



HANDLES
COLLECTION

BRONZE

Renaissance
CUSTOM HARDWARE

A valued brand of

FR International

www.FRInternational.com



GIARA

Giara è il frutto della passione che Ruggero Frascio, Emanuela Pasini e i figli Giacinto e Raffaele dedicano alla loro attività: ideare e produrre maniglie e accessori d'arredo. Le collezioni BRONZE, GIARA ART DESIGN, KLEIS e RDS rappresentano quattro mondi, quattro modi di intendere l'arredamento, in cui la maniglia diventa complemento di design capace di donare quel dettaglio unico che impreziosisce la casa.

Giara is the result of the passion that Ruggero Frascio, Emanuela Pasini and their sons Giacinto and Raffaele dedicate to their business: designing and producing handles and furnishing accessories. The BRONZE, GIARA ART DESIGN, KLEIS and RDS collections represent four worlds, four ways of interpreting furniture, in which the handle becomes a design accessory capable of providing that unique detail that enhances the home.

Giara ist das Ergebnis einer Leidenschaft, mit der Ruggero Frascio, Emanuela Pasini und ihre Söhne Giacinto und Raffaele, Griffe und Einrichtungszubehör entwerfen und produzieren. Die Kollektionen BRONZE, GIARA ART DESIGN, KLEIS und RDS stehen für vier Welten und vier Arten. Die Griffe werden zu Designerstücken, die in der Lage sind, mit einem einzigartigen Detail das Haus wertvoller zu machen.

Giara est la passion que Ruggero Frascio, Emanuela Pasini et leurs enfants Giacinto et Raffaele consacrent à leur activité qui est de produire des poignées de porte et accessoires de meubles. Les collections BRONZE, GIARA ART DESIGN, KLEIS et RDS représentent quatre mondes, quatre manières d'interpréter la production, dans laquelle la poignée de porte devient un accessoire de design capable d'apporter ce détail unique qui permet de valoriser la maison.

Distributed under agreement as

Renaissance
CUSTOM HARDWARE

FR International, LLC

1011 3rd Avenue S.W.
Carmel, Indiana USA 46032

1-800-238-9711

www.FRIInternational.com

BRONZE



Bronze: Emotion einer mehr als 4000-jährigen Geschichte

GIARA präsentiert Kreationen, die Kultur und den Zauber der Bronze gemäß dem klassischen und dem zeitgenössischen Geschmack.

Il Bronzo: emozione di una storia antica più di 4000 anni

GIARA presenta le creazioni, la cultura e il fascino del bronzo dal gusto classico a quello contemporaneo.

Le bronze : une émotion d'une histoire agée de plus de 4000 ans

GIARA présente les créations, la culture et le charme du bronze du classique au contemporain.

The Bronze: an emotion of a more than 4000 years of ancient history

GIARA presents the creations, the culture and the charm of bronze from classical to contemporary styles.

Indice / Index / Inhaltsverzeichnis / Index

Storia e tradizione pag. 4-5
History and tradition
Geschichte und Tradition
Histoire et tradition

Le certificazioni. Una promessa di qualità pag. 6
Certifications. Our promise of quality
Die Zertifizierungen.
Unser Qualitätsversprechen
Les certifications. Une promesse de qualité.

Eco antico. Il rame antibatterico pag. 7
Ancient eco. The antibacterial copper
Altes Echo. antibakterielles Kupfer
Echo ancien. Cuivre antibactérien

Le finiture naturali del bronzo pag. 8-9
The natural finishes of bronze
Das natürliche Finish der Bronze
Les finitions naturelles du bronze

tailor
made
Bronze

Tailor made Bronze pag. 10-19

Articoli su misura
Custom-made items
Maßgefertigte Artikel
Articles sur mesure

Indice collezioni maniglie pag. 21
Handles collection index
Inhaltsverzeichnis - Türgriff-Kollektion
Index collection de poignées

BRONZE

classico contemporaneo pag. 22-53



collezione bronzo pag. 54-95

collezione ottone pag. 96-105

Accessori pag. 106-107
Accessories
Zubehör
Accessoires

Accessori per mobili pag. 118-119
Accessories for furnitures
Zubehör für Möbel
Accessoires pour meubles

Materiali e finiture pag. 144-145
Materials and finishes
Materialien und Finish
Matériaux et finitions

Storia e tradizione

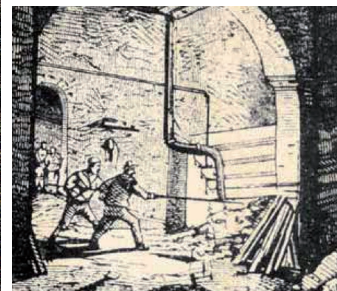

L'arte della fusione del Bronzo esiste nella nostra valle da più di quattromila anni. Recenti indagini archeologiche condotte in un piccolo abitato in media Valle Sabbia sulla Corna Nibbia mostrano stampi in terracotta, scorie di fusione di bronzo e manufatti che testimoniano l'antica tradizione metallurgica risalente al 1.800 A.C.

È possibile ammirare questi preziosi reperti al Museo Archeologico della Valle Sabbia a Gavardo intitolato "L'uomo e il metallo nei secoli".

GIARA è orgogliosa di continuare oggi – tramandandola e rinnovandola – la produzione di preziosi oggetti negli stessi luoghi in cui i nostri progenitori iniziarono questa nobile tradizione.

Le collezioni Bronze e Giara Art design sono frutto di una profonda ricerca negli stili che hanno caratterizzato le varie epoche dell'arte e dell'architettura.

I nostri prodotti sono realizzati in lega BRITANNIUM e BRONZO, prestigiosi metalli di origine medioevale, fusi e lavorati manualmente nel rispetto delle antiche tradizioni artigianali della zona.

Gli articoli vengono proposti in finitura naturale non verniciata, secondo le attuali norme ambientali ed ecologiche.

History and tradition

The art of bronze casting has existed in our valley for more than four thousand years. Recent archaeological investigations conducted in a small town in the middle Valle Sabbia on the Corna Nibbia show terracotta moulds, bronze casting slags and artefacts which demonstrates the ancient metallurgical tradition dating back to 1800 BC.

These precious finds can be admired at the Valle Sabbia Archaeological Museum to Gavardo entitled "L'uomo e il metallo nei secoli" (Man and metal over the centuries). Giara is proud to continue today - passing it on and reinventing it - the production of precious objects in the same places where our ancestors began this noble tradition.

The Bronze and Giara Art design collections are the result of in-depth research into the styles which have characterised the various eras of art and architecture. Our products are made of BRITANNIUM and BRONZE alloy, prestigious metals of medieval origin, cast and hand-shaped respecting the most ancient craft traditions of the area.

The articles are offered in an unlacquered natural finishes, according to current environmental and ecological standards.



Geschichte und Tradition

Die Kunst des Bronzegusses gibt es in unserem Tal schon seit mehr als viertausend Jahren. Bei archäologischen Untersuchungen, die in der letzten Zeit in einem kleinen Dorf mitten im Valle Sabbia an der Corna Nibbia durchgeführt wurden, stieß man auf Terrakotta-Formen, Bronzeguss-Schlacke und Gegenstände, die von der alten metallurgischen Tradition aus dem Jahr 1.800 v. Chr. zeugen.

Diese wertvollen Fundstücke können Sie im Archäologischen Museum des Valle Sabbia in Gavardo unter dem Titel „L'uomo e il metallo nei secoli“ (Mensch und Metall im Laufe der Jahrhunderte) betrachten. GIARA ist stolz darauf - durch Überlieferung und Erneuerung - mit der Produktion von wertvollen Gegenständen an den gleichen Orten fortzuführen, an denen unsere Vorfahren diese großartige Tradition angefangen haben.

Die Kollektionen Bronze und Giara Art design sind das Ergebnis einer intensiven Untersuchung der Stile, die in unterschiedlichen Epochen charakteristisch für die Kunst und die Architektur waren.

Unsere Produkte werden aus den Legierungen BRITANNIUM und BRONZE hergestellt, edle Metalle mittelalterlichen Ursprungs, die nach alter Handwerkstradition von Hand geschmolzen und bearbeitet werden. Die Produkte werden gemäß den geltenden Umwelt- und Ökostandards in natürlicher, nicht lackierter Ausführung angeboten.

Histoire et tradition

L'art de la fusion du bronze existe dans notre vallée depuis plus de quatre mille ans. De récentes recherches archéologiques menées dans un petit bourg dans la moyenne vallée dénommée Valle Sabbia sur la Corna Nibbia dévoilent des moules en terre cuite, des scories de fusion du bronze et des objets réalisés par l'homme qui témoignent de l'ancienne tradition métallurgique remontant à 1800 avant J-C.

Il est possible d'admirer ces pièces uniques au musée archéologique de la Valle Sabbia à Gavardo appelé « l'homme et le métal à travers les siècles ». GIARA est fière de continuer aujourd'hui, en la transmettant et en la renouvelant, la production d'objets précieux dans les mêmes lieux dans lesquels nos aïeux commencèrent cette noble tradition.

Les collections Bronze et Giara Art design sont le résultat d'une recherche approfondie dans les styles qui ont caractérisé les différentes époques de l'art et de l'architecture.

Nos produits sont conçus en alliage BRITANNIUM et BRONZE, des métaux prestigieux d'origine médiévale, fondus et travaillés à la main dans le respect des traditions artisanales de la région.

Les produits sont proposés en finition naturelle non vernie, dans le respect des normes environnementales et écologiques actuelles.



Le certificazioni



Una promessa di qualità

L'impegno di GIARA nell'aver avviato un costante percorso di miglioramento qualitativo è testimoniato dall'adesione alle più importanti certificazioni internazionali testate periodicamente da organi di verifica esterni.

ISO 14001 è una norma internazionale ad adesione volontaria, per esserne conformi bisogna definire una politica aziendale specifica in materia ambientale, quindi applicare e mantenere attive le attività, le procedure e le registrazioni previste, tra cui la riduzione degli sprechi (consumi idrici, risorse energetiche, ecc.).

GIARA risulta tra le poche aziende del settore ad avere ottenuto questa importante certificazione.

ISO 9001 è una normativa volta al miglioramento continuo dell'azienda, con l'obiettivo di ottimizzare la struttura organizzativa. Si tratta di una scelta strategica per le imprese che vogliono incrementare la propria produzione, abbattere i costi, diventare più competitive sul mercato e aumentare la fidelizzazione della clientela. ISO 9001 è lo standard più conosciuto e utilizzato per i sistemi di gestione della qualità di tutto il mondo.

Certifications. Our promise of quality

GIARA's commitment started with continuous improvement of quality guaranteed by the adherence to the most important international certifications periodically tested by external auditors.

ISO 14001 is a voluntary international standard. In order to comply a specific company policy must be defined on environmental issues, then apply and maintain the activities, procedures and records required, including the reduction of waste (water consumption, energy resources, etc.).

GIARA is among the few companies in the industry to have obtained this important certification.

ISO 9001 is a standard aimed at the continuous improvement of the company, with the objective of optimizing the organisational structure. This is a strategic choice for companies who wish to increase their production, cut costs, become more competitive on the market and increase customer loyalty. ISO 9001 certification is the best known and most used standard for quality management systems worldwide.

Die Zertifizierungen. Unser Qualitätsversprechen

Die Verpflichtung von GIARA zur ständigen Verbesserung wird von den wichtigsten internationalen Zertifizierungen bestätigt, die periodisch von externen Prüforganen ausgestellt werden.

ISO 14001 ist eine internationale Norm, der man freiwillig beitreten kann. Um konform zu sein, ist es notwendig, eine spezifische Unternehmenspolitik zu Umweltfragen zu definieren. Die vorgesehenen Tätigkeiten, Verfahren und Registrierungen werden eingehalten und unter Beachtung der vorhandenen Ressourcen durchgeführt (Wasserverbrauch, Energieressourcen usw.).

Giara ist eine der wenigen Firmen der Branche, die diese wichtige Zertifizierung erhalten hat.

ISO 9001 ist eine Norm, die auf die kontinuierliche Verbesserung des Unternehmens abzielt, um die Organisationsstruktur zu optimieren. Es ist eine strategische Entscheidung für Unternehmen, die ihre Produktion steigern, Kosten senken, auf dem Markt wettbewerbsfähiger --- und die Kundenbindung erhöhen wollen. Die ISO 9001 ist die bekannteste und am weitesten verbreitete Norm für Qualitätsmanagementsysteme weltweit.

Les certifications. Une promesse de qualité

L'engagement de Giara dans un parcours qualitatif est attesté par son adhésion aux plus importantes certifications internationales, testées régulièrement par les organes de contrôle externes.

La norme ISO 14001 est une norme internationale à adhésion volontaire. Pour s'y conformer il est nécessaire de définir une politique spécifique et environnementale, donc d'appliquer et maintenir actifs les activités, procédures et enregistrements prévus, parmi lesquels la diminution des gaspillages (consommations hydriques, ressources énergétiques, etc...)

Giara fait partie des quelques entreprises du secteur à avoir obtenu cette certification internationale.

ISO 9001 est une norme visant à l'amélioration continue de l'entreprise, avec l'objectif d'optimiser sa structure. Il s'agit d'un choix stratégique pour les entreprises qui veulent accroître leur production, réduire les coûts, devenir plus compétitives sur le marché et augmenter la fidélisation de leur clientèle. ISO 9001 est la norme la plus connue et la plus utilisée pour les systèmes de gestion de la qualité du monde entier.

Eco antico

Antimicrobial
Copper



Sezione maniglia in Bronzo
Handle section in Bronze
Griffteil in Bronze
Section de poignée en bronze

Rame Copper Kupfer Cuivre >80%
Stagno Tin Zinn Étain <20%

“La caratteristica del nostro prodotto, frutto di pluriennale esperienza nel settore è di essere proposto in finitura naturale non verniciato secondo norme ambientali ed ecologiche attuali”.

Scopriamo con alcune semplici domande le proprietà del bronzo.

Che cosa è il bronzo?

Il bronzo è una lega rame-stagno. La sua caratteristica è l'alta percentuale di rame presente nella lega che è al di sopra dell'80%. Il bronzo combina proprietà di resistenza e buona lavorabilità e offre un'ampia scelta dei colori ottenuta con antiche lavorazioni di ossidazione delle superfici e con trattamenti superficiali a base di cera naturale.

L'alta percentuale di rame presente nel Bronzo e le sue finiture sono gli elementi distintivi di questo prezioso materiale.

Il rame ha proprietà antibatteriche?

Sì, e sono state sfruttate dall'uomo fin dall'antichità in quanto è un minerale antibatterico naturale, igienico ed efficace contro microrganismi patogeni ambientali. Proprietà che sono state dimostrate da ricerche scientifiche condotte negli ultimi decenni.

Come fa ad eliminare i batteri?

Il rame è un nutriente essenziale sia per gli esseri umani che per i batteri, ma in alte dosi, gli ioni rame possono causare una serie di eventi negativi per la cellula batterica. Quando vengono pulite con regolarità, le superfici antimicrobiche in rame, ottone e bronzo eliminano più del 99,9% dei batteri presenti entro due ore di esposizione, anche dopo ripetute “contaminazioni”.

Dove può essere utilizzato?

Il rame e le sue leghe possono essere applicati come superfici che vengono toccate di frequente in ospedali, case di cura, palestre, scuole, uffici, mezzi ed edifici pubblici.

Ancient eco

“the characteristic of our product, which is the result of many years of experience in the industry, is that it is offered in a natural, unlacquered finish according to current environmental and ecological standards”.

Let's discover the properties of bronze:

What is bronze?

Bronze is an alloy of copper and tin. Its characteristic is the high percentage of copper present in the alloy which is above 80%. Bronze combines resistance properties and good workability and offers a wide choice of colours obtained with oxidation processes of the surfaces and with surface treatments based on natural wax. The high percentage of copper in Bronze and its finishes is the distinctive feature.

Does copper have antibacterial properties?

Yes, and they have been exploited by humans since ancient times as it is a natural, hygienic, antibacterial mineral and effective against environmental pathogenic micro-organisms.

These properties have been proven by scientific research conducted in last few decades.

How does it kill bacteria?

Copper is an essential nutrient for humans as well as bacteria, but in high doses, copper ions can cause a series of negative events in bacterial cells. When cleaned regularly, antimicrobial copper, brass and bronze surfaces eliminate more than 99.9% of the bacteria present within two hours of exposure, even after repeated “contamination”.

Where can it be used?

Copper and its alloys can be applied as surfaces that are frequently touched in hospitals, nursing homes, gyms, schools, offices, public transport and buildings.

Altes Echo

„Unser Produkt zeichnet sich durch eine langjährige Erfahrung in der Branche aus und wird in einer natürlichen, nicht lackierten Ausführung angeboten, die den aktuellen Umwelt- und Ökostandards entspricht.“

Wir entdecken die Eigenschaften von Bronze anhand von einigen einfachen Fragen:

Was ist Bronze?

Bronze ist eine Kupfer-Zinn-Legierung. Charakteristisch ist der hohe Kupferanteil von über 80% in der Legierung. - Bronze vereint Eigenschaften, wie Strapazierfähigkeit und gute Verarbeitbarkeit und bietet eine große Auswahl an Farben, die durch - Oxidationsprozesse der Oberflächen und durch Oberflächenbehandlungen auf Basis von natürlichem Wachs erzielt werden.

Der hohe Kupferanteil in Bronze und seine Oberflächen sind die charakteristischen Elemente dieses edlen Materials.

Hat Kupfer antibakterielle Eigenschaften?

Ja, - sie werden seit der Antike vom Menschen genutzt, da es sich um ein natürliches antibakterielles Mineral handelt, das hygienisch und wirksam gegen krankheitserregende Mikroorganismen aus der Umwelt ist. Diese Eigenschaften sind durch wissenschaftliche Untersuchungen der letzten Jahrzehnte belegt.

Wie entfernt es Bakterien?

Kupfer ist sowohl für den Menschen als auch für Bakterien ein wesentlicher Nährstoff. Wenn aber die Legierung hoch dosiert wird, wirken Kupferionen negativ auf die Bakterienzelle. - Bei regelmäßiger Reinigung entfernen antimikrobielle Kupfer-, Messing- und Bronzeoberflächen - auch nach wiederholter „Kontamination“ - innerhalb von zwei Stunden mehr als 99,9% der vorhandenen Bakterien.

Wo kann es verwendet werden?

Kupfer und seine Legierungen können für Oberflächen, die viel berührt werden - in Krankenhäusern, Pflegeheimen, Turnhallen, Schulen, Büros, Fahrzeugen und öffentlichen Gebäuden - verwendet werden.

Echo ancien

« La caractéristique de notre produit, résultat d'une expérience pluriannuelle dans le secteur est d'être proposée avec une finition naturelle non vernie selon des normes environnementales et écologiques actuelles ».

Découvrons avec quelques questions simples les propriétés du bronze.

Le bronze qu'est-ce que c'est ?

Le bronze est un alliage cuivre-étain. Il est caractérisé par son pourcentage élevé de cuivre : plus de 80%. Il combine des propriétés de résistance et de bonne usinabilité et offre un large choix des couleurs obtenu par des procédés d'oxydation des surfaces et par des traitements de surface à base de cire naturelle. Le pourcentage élevé de cuivre présent dans le bronze et ses finitions sont les éléments particuliers de ce précieux matériau.

Est-ce que le cuivre a des propriétés antibactériennes ?

Oui, elles ont été exploitées par l'homme depuis l'antiquité. Le cuivre est un minéral bactéricide naturel contre les micro-organismes pathogènes. Ce sont des propriétés qui ont été démontrées par des recherches scientifiques menées au cours de ces dernières décennies.

Comment fait-il pour se débarrasser des bactéries ?

Le cuivre est un complément alimentaire important aussi bien pour les êtres humains que pour les bactéries, mais à hautes doses, les ions cuivre peuvent néfastes pour la cellule bactérienne. Lorsque celles-ci sont régulièrement nettoyées, les surfaces antimicrobiennes en cuivre, laiton et bronze éliminent plus de 99,9% des bactéries présentes jusqu'à deux heures d'exposition, même après des contaminations « répétées ».

Où peut-il être utilisé ?

Le cuivre et ses alliages peuvent être utilisés sur des surfaces qui sont souvent touchés dans les hôpitaux, maisons de santé, gymnases, écoles, bureaux, moyens de transport, bâtiments publics, etc.

Le finiture naturali del bronzo

I colori del Bronzo sono vivi, profondi, irripetibili, spaziano dal colore argenteo al nero più profondo passando dai colori del bruno al verde fino al giallo in diverse sfumature. Ogni colore svela un sentimento, un carattere dovuto alle lavorazioni fatte di patinature con ingredienti legati alla storia millenaria di questo materiale.

Mani abili e ingredienti custoditi nella più antica tradizione consentono al bronzo di liberarsi in un'armonia di colori così intensi quanto singolari.

Ogni pezzo di bronzo è unico nel suo colore, nelle sue sfumature. Lo sentiamo vivo perché in esso si riconosce l'anima di un materiale che si manifesta nel millenario rapporto con l'uomo.

The natural finishes of bronze

The charm of bronze colors comes from a thousand-year history of wisdom, tradition and love for this noble material.

The Bronze colours are lively, deep, unrepeatable, ranging from silvery to the deepest black, passing from the colours of brown to green till yellow in different shades. Each colour reveals a feeling, a character due to the processing made of coatings with ingredients linked to the ancient history of this material.

Skilful hands and ingredients treasured in the most ancient tradition allow the bronze to be released in a harmonious blend of colours as intense as they are unique. Each piece of bronze is unique in its colour and shades, that we feel alive because we recognize the soul of a material in it which manifests itself in the millennial relationship with humans.

Das natürliche Finish der Bronze

Der Zauber der Farben der Bronze beruht auf einer tausendjährigen Geschichte des Wissens, der Tradition und der Liebe zu diesem edlen Material.

Die Farben der Bronze sind lebendig, tief_ und einzigartig. Sie reichen von Silber bis zu tiefem Schwarz und gehen in verschiedenen Schattierungen von Brauntönen über Grün bis zu Gelb.

Jede Farbe offenbart ein Gefühl, einen Charakter, der durch die Patinierung entsteht, deren Bestandteile mit der alten Geschichte dieses Materials verbunden sind.

Geschickte Hände und Bestandteile gemäß der Tradition erlauben dem Material Bronze, eine Harmonie von Farben zu erzeugen, die so intensiv wie einzigartig sind.

Jedes Stück Bronze ist einzigartig in seiner Farbe und in seinen Nuancen, die wir lebendig empfinden, weil wir darin die Seele eines Materials erkennen, die in der tausendjährigen Beziehung zum Menschen zum Ausdruck kommt.

Les finitions naturelles du bronze

Le charme ses couleurs rappelle l'amour et la tradition de cet antique matériau.

Les couleurs du bronze sont vives, profondes et exceptionnelles. Elles vont de la couleur argentée au noir plus profond, en passant par les couleurs du brun au vert jusqu'au jaune dans différentes nuances.

Chaque couleur dévoile un sentiment, un caractère dus aux transformations constituées par des vernis avec des ingrédients liés à l'histoire millénaire de ce matériau.

Des mains habiles et des ingrédients gardés dans la plus pure tradition permettent au bronze de se libérer une harmonie de couleurs intenses et singulières.

Chaque pièce en bronze, par sa couleur, ses tons, ses formes est unique et nous rappelle les traditions qui la caractérisent.

Il fascino dei colori del bronzo nasce da una storia millenaria di sapienza, tradizione e amore per questo nobilissimo materiale

BRONZO ROSSO
RED BRONZE
ROTE BRONZE
BRONZE ROUGE

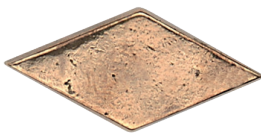

BRONZO BIANCO
WHITE BRONZE
WEISSBRONZE
BRONZE BLANC



OTTONE
BRASS
MESSING
LAITON

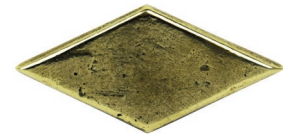

finiture / finishings / Veredelungen / finitions

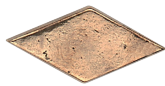

1 - NB
Bronzo naturale
Natural bronze
Natur Bronze / Bronze naturel



5 - WB
Bronzo bianco
White bronze
Weiß Bronze / Bronze blanc

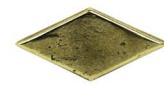

9 - NOT
Ottone naturale
Natural brass
Natur Messing / Laiton naturel

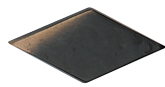

2 - AZ
Bronzo antico
Aged bronze
Antik-Bronze / Bronze antique



6 - AS
Argento antico
Aged silver
Antik-Silber / Argent ancien



S - NOL
Ottone naturale lucidato
Natural polished brass
Natur Messing poliert / Laiton naturel poli

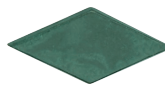

3 - VI
Verde imperiale
Verdegreen
Kupfergrün / Vert impérial

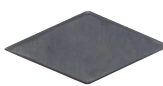

7 - AI
Ferro antico
Aged iron
Veraltetes Eisen / Fer antique



4 - RUB
Bronzo grezzo cerato
Rustic waxed bronze
Bronze gewachst / Bronze brut ciré



Y - OPW
Peltro antico
Aged pewter
Antik-Zinn / Etain antique

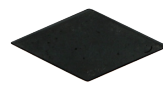

Z - BLK
Bronzo nero
Black bronze
Schwartzte Bronze / Bronze noir

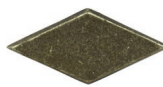

8 - RUW
Bronzo bianco grezzo cerato
Rustic waxed white bronze
Rohe Weissbronze gewachste
Bronze blanc brut ciré



tailor made Bronze

Articoli su misura

GIARA mette a disposizione la sua tradizionale esperienza e la sua conoscenza per le lavorazioni di alto artigianato, realizzando pezzi unici nati dalla creatività di artisti, architetti, designer. L'ideazione e realizzazione di prodotti su misura in questi anni ha avuto un forte incremento, dando vita ad una specializzazione che sta consolidando GIARA fra gli operatori più qualificati.

Custom-made items

GIARA offers its traditional experience and expertise in high craftsmanship, creating unique pieces born from the creativity of artists, architects and designers.

In recent years, there has been an increase in the demand for the design and production of custom-made products. This has pushed for the growth of this specialization that is consolidating GIARA's reputation among the most qualified operators.

Maßgefertigte Artikel

GIARA stellt seine Erfahrung und sein Wissen über hohe Handwerkskunst zur Verfügung und fertigt einzigartige Stücke an, die durch die Kreativität von Künstlern, Architekten und Designern entstehen. Die Planung und Realisierung von maßgefertigten Produkten hat in den letzten Jahren stark zugenommen, wodurch eine Spezialisierung entstanden ist, die den Ruf von GIARA unter den qualifizierten Anbietern konsolidiert.

Articles sur mesure

GIARA met à disposition toute son expérience, en réalisant des pièces uniques nées de la créativité d'artistes, d'architectes et de designers. La réalisation de produits sur mesure au cours de ces dernières années a connu une forte augmentation et permis à GIARA de devenir un spécialiste reconnu parmi les opérateurs les plus qualifiés.

GIARA



Un processo di alta professionalità



GIARA segue i progettisti per la realizzazione di progetti su misura e condivide con loro le fasi di sviluppo inerenti alla produzione.

L'analisi preliminare dei progetti, le verifiche di fattibilità, la realizzazione dei prototipi, lo sviluppo della produzione e l'assistenza nell'applicazione e manutenzione dei prodotti vengono seguite in un rapporto reciproco di fiducia.

A process of high professionalism

GIARA follows the designers for the manufacturing of custom-made projects and shares with them the development phases related to production.

Preliminary project analysis, feasibility checks, prototype construction, production development and product application and maintenance assistance are carried out in a mutual relationship of trust.

Ein extrem professioneller Prozess

GIARA begleitet die Designer bei der Entwicklung von maßgefertigten Projekten und teilt mit ihnen die zur Produktion gehörenden Entwicklungsphasen.

Die Voranalyse der Projekte, die Machbarkeitsprüfungen, die Anfertigung der Prototypen, die Entwicklung der Produktion und die Unterstützung bei der Anwendung und Wartung der Produkte erfolgen in einem gegenseitigen Vertrauensverhältnis.

Un processus de grand professionnalisme

GIARA suit les designers pour la réalisation de projets prestigieux et partage avec eux les phases de développement relatifs à la production.

L'analyse préliminaire des projets, les vérifications de faisabilité, la réalisation des prototypes, le développement de la production, l'assistance dans l'application et l'entretien des produits sont suivis dans un rapport réciproque de confiance.

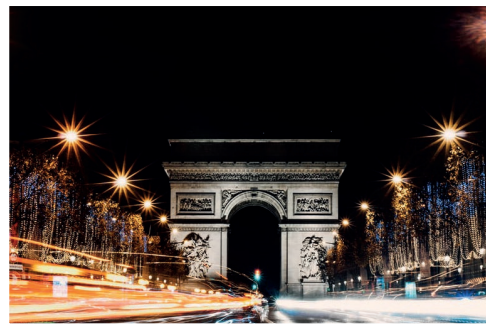

HOTEL
PARIS - FRANCE

paris

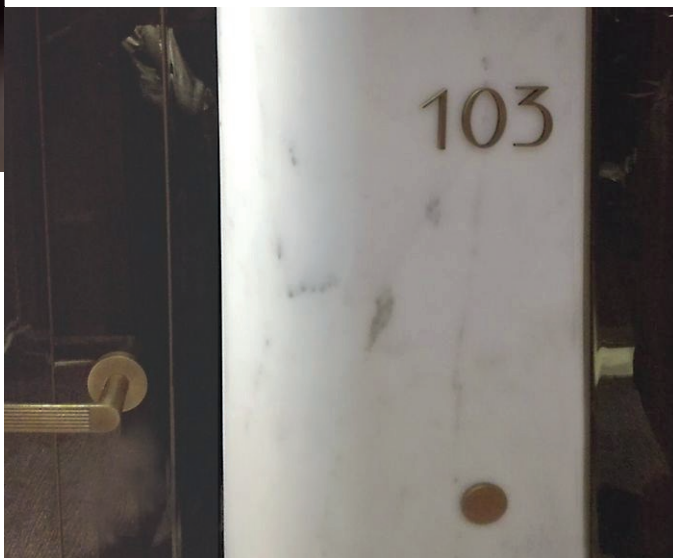

RESIDENZA PRIVATA
GENÈVE - SWISSE

Progetti di grande prestigio accolgono
le realizzazioni di GIARA

Che siano residenze o alberghi, GIARA ha collaborato con diversi progettisti nella realizzazione delle finiture in bronzo per le loro opere architettoniche. Conoscenza profonda dei metalli e sensibilità ai dettagli, hanno consentito a GIARA di collaborare in opere esclusive in Italia e nel mondo.

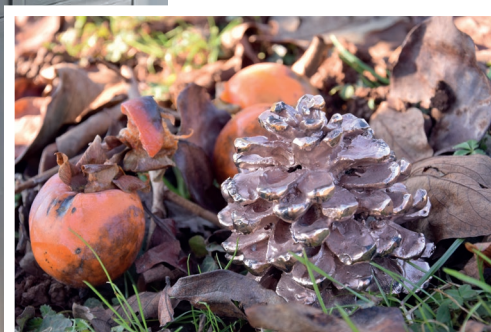

genève



MASSERIA CALDERISI
SAVELLETRI DI FASANO

salento



Projects of great prestige welcome GIARA's "on-off" products

Whether they are homes or hotels, GIARA has collaborated with several designers in the manufacturing of bronze finishes for their architectural projects. Thanks to the deep knowledge of metals and attention to detail, GIARA has been able to collaborate in exclusive projects in Italy and around the world.

Anerkannte Projekte beherbergen die „on-off“-Kreationen von GIARA

Egal ob es sich um Wohnanlagen oder Hotels handelt, GIARA arbeitet mit mehreren Designern zusammen, um deren architektonische Werke mit Bronze zu veredeln. Ein umfassendes Wissen über Metalle und Sensibilität für Details haben es GIARA ermöglicht, an exklusiven Projekten in Italien und in der ganzen Welt mitzuarbeiten.

Des projets de grand prestige accueillent les réalisations « on-off » de GIARA

Qu'il s'agisse de résidences ou bien d'hôtels, GIARA a collaboré avec différents designers dans la réalisation des finitions en bronze pour leurs œuvres architecturales. La connaissance approfondie des métaux et la sensibilité aux détails, ont permis à GIARA de collaborer dans des œuvres exclusives en Italie et dans le monde.

cala di volpe



DESIGN 4BI&ASSOCIES
CALA DI VOLPE



RESIDENZA PRIVATA
CALA DI VOLPE



tarvisio



HOTEL HAMMERACK
MALBORGHETTO - VALBRUNA



RESIDENZA PRIVATA
PORTOVENERE



riviera ligure



HOTEL
LYON - FRANCE

lyon



CORTEXA

Il nuovo segno
nell'Art Architectural Design

progetto Cortexa

Ispirato alla natura delle screpolature degli alberi, Cortexa rappresenta il medium per far emergere l'emozione in una linea di accessori d'arredo, che hanno protagonista il bronzo fuso e svelando un carattere forte e coinvolgente. La linea si compone di elementi che adornano la casa, come rivestimenti per camini o altri accessori che esaltano l'unicità della collezione.

The new sign in Art Architectural Design

Inspired by the characteristics of tree bark cracks, Cortexa represents the medium to bring out the emotion in a line of furnishing accessories in molten bronze which reveal a strong and engaging nature. The line consists of décor elements for the home, such as chimney coverings or other accessories that enhance the uniqueness of this collection.

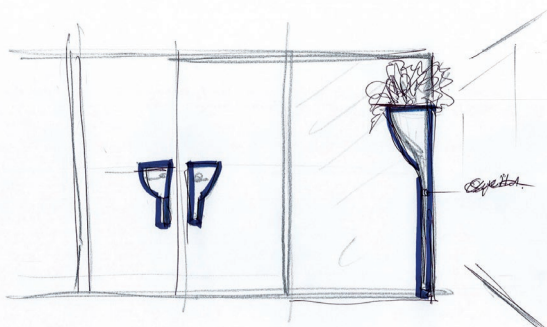

*work in progress
progetto a cura di BCF design*

*work in progress
project by BCF design*

*Work in Progress
Projekt von BCF design*

*Travail en cours
projet sous la direction de BCF design*





Das neue Zeichen im Art Architectural Design

Inspiriert von der Natur der Baumrinne stellt Cortexa das Medium dar, um Emotionen in einer Produktlinie von Einrichtungszubehör hervorzubringen. Protagonist ist der Bronzeguss, der einen starken und einnehmenden Charakter übermittelt. Die Produktlinie besteht aus Elementen, die das Haus schmücken, wie Kamineinfassungen oder andere Accessoires, welche die Einzigartigkeit der Kollektion unterstreichen.

Le nouveau signe dans l'Art Architectural Design

Inspiré de la nature de l'écorce des arbres, Cortexa représente le moyen pour faire émerger l'émotion dans une ligne d'accessoires de décoration, qui ont comme protagoniste le bronze fondu et la nature dévoilant ses formes et sa force. La ligne se compose d'éléments valorisants, comme les revêtements pour cheminées et autres accessoires qui exaltent la spécificité de la collection.

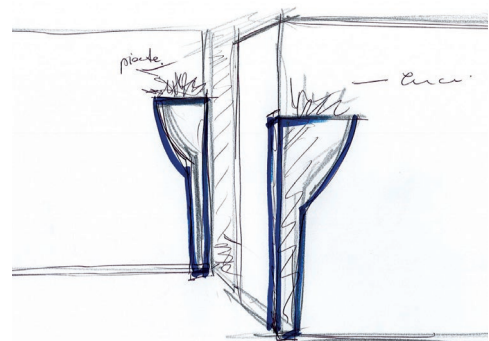



Anima Eterna

Il bronzo è un materiale intimamente legato all'uomo per la sua storia millenaria, ma anche per la sua capacità di "evocare" emozioni. Questa duplice anima, che raccoglie le testimonianze del passato e al tempo stesso può divenire anticipatore di nuovi trend, si esprime nelle nostre due collezioni BRONZE e GIARA ART DESIGN.

Eternal Soul

Bronze is a material intimately linked to man not only for its thousand-year history, but also for its ability to "evoke" emotions. This dual soul, which collects the testimonies of the past and at the same time can become a preview of new trends, is expressed in our two collections, BRONZE and GIARA ART DESIGN.

Ewige Seele

Bronze ist ein Material, das aufgrund seiner jahrtausendealten Geschichte und aufgrund seiner Fähigkeit, Emotionen zu „wecken“ eng mit der Menschheit verbunden ist. Diese doppelte Seele, die die Zeugnisse der Vergangenheit sammelt und gleichzeitig zum Wegbereiter neuer Trends werden kann, kommt in unseren beiden Kollektionen BRONZE und GIARA ART DESIGN zum Ausdruck.

Âme Eternelle

Le bronze est un matériau intimement lié à l'homme en raison de son histoire millénaire, mais également pour sa capacité « d'évoquer » des émotions. Cette combinaison, qui recueille les témoignages du passé et annonce les nouvelles tendances, s'exprime dans nos deux collections BRONZE et GIARA ART DESIGN.

Indice collezioni maniglie / Handles collection index
Inhaltsverzeichnis - Türgriff-Kollektion / Index collection de poignées

BRONZE

classico contemporaneo



collezione **Arco**
24-27



collezione **Cosmo**
28-31



collezione **La**
32-35



collezione **Langhe**
36-37



collezione **Liscia**
38-41



collezione **Milano**
42-45



collezione **Onda**
46-49



collezione **Quadra**
50-53



collezione bronzo



collezione **Chemin de Fer**
56-59



collezione **Conchiglia**
60-63



collezione **Firenze**
64-65



collezione **Gotica**
66-69



collezione **Impero**
70-71



collezione **Mossa**
72-73



collezione **Ottagonale**
74-75



collezione **Ovale**
76-79



collezione **Perla**
80-81



collezione **Torciglia**
82-85



collezione **Tronco**
86-89



collezione **Virgola**
90-91



collezione **Wave**
92-93



collezione **Wave Alpine**
94



collezione ottone



collezione **Ala**
98-99



collezione **Cono**
100-101



collezione **Mila**
102-103



collezione **Tosca**
104-105



BRONZE

classico contemporaneo

Il design contemporaneo che incontra il bronzo



La linea Bronze è l'espressione di un design contemporaneo che si arricchisce della natura del bronzo, con i suoi colori, con la sua inimitabile matericità. Un incontro reso possibile dalla grande esperienza plasmatrice di Giara Art design nelle lavorazioni bronzee.

Contemporary design that meets bronze

The Bronze line is the expression of a contemporary design that is enriched by the nature of bronze, its colors and its inimitable materiality. A fusion made possible by Giara Art design's great moulding experience in bronze workmanship.

Das zeitgenössische Design trifft - Bronze

Die Linie Bronze ist der Ausdruck eines zeitgenössischen Designs, das die Natur der Bronze mit ihren Farben und ihrer einzigartigen Beschaffenheit nutzt. Dies wurde dank der schöpferischen Erfahrung von Giara Art design mit der Verarbeitung von Bronze ermöglicht.

Le design contemporain qui rencontre le bronze

La ligne Bronze est l'expression d'un design contemporain qui s'enrichit de la nature du bronze, avec ses couleurs et ses formes. Une rencontre rendue possible grâce à l'expérience créatrice étendue de Giara Art design dans les transformations en bronze.



collezione **Arco**

Il tratto contemporaneo – con la superficie arcuata che ne esalta il dinamismo – si fonde con la materia bronzea, assumendo un aspetto caldo, sensuale. Arco si abbina a un'architettura che privilegia materiali naturali, in linea con le nuove frontiere del green design.

The contemporary trait – with the arched surface that enhances its vitality – blends with the bronze material, taking on a warm, sensual appearance. Arco is the perfect match for an architecture style that favors natural materials, in line with the new frontiers of green design.

Der zeitgenössische Charakterzug - mit der gebogenen Oberfläche, die die Dynamik unterstreicht - verschmilzt mit dem Material Bronze und nimmt ein warmes, sinnliches Aussehen an. Arco wird mit einer Architektur kombiniert, die - im Einklang mit den neuen Grenzen des grünen Designs - natürliche Materialien bevorzugt.

La trait contemporain - avec la surface arquée qui en exalte le dynamisme - se fond avec la matière en bronze, en prenant un aspect chaud et sensuel. Arco se marie avec une architecture qui privilégie des matériaux naturels, conformes avec les nouvelles frontières du green design.

BRONZE

collezione Arco

design BCF Studio

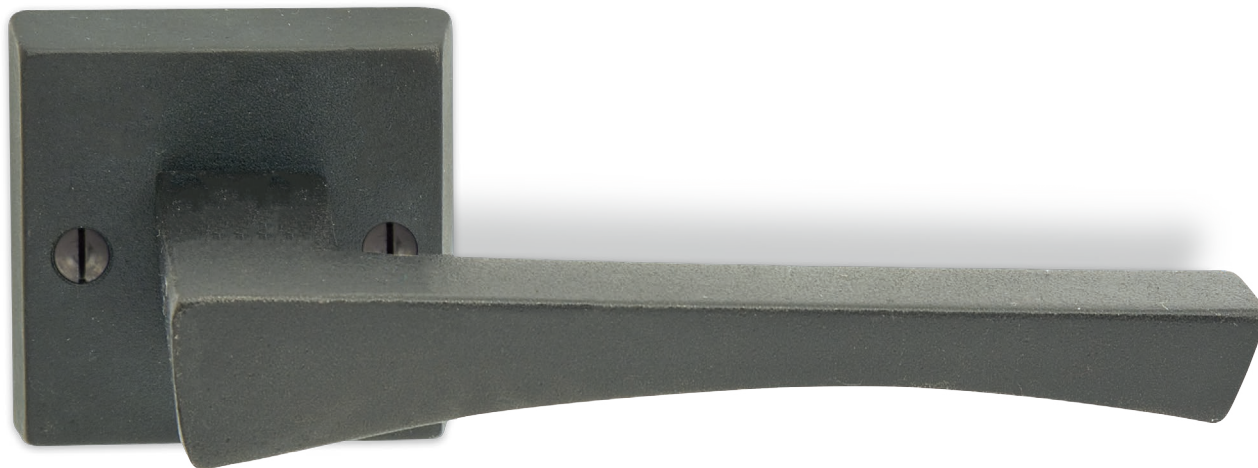

Arco/R12 - finish BLK

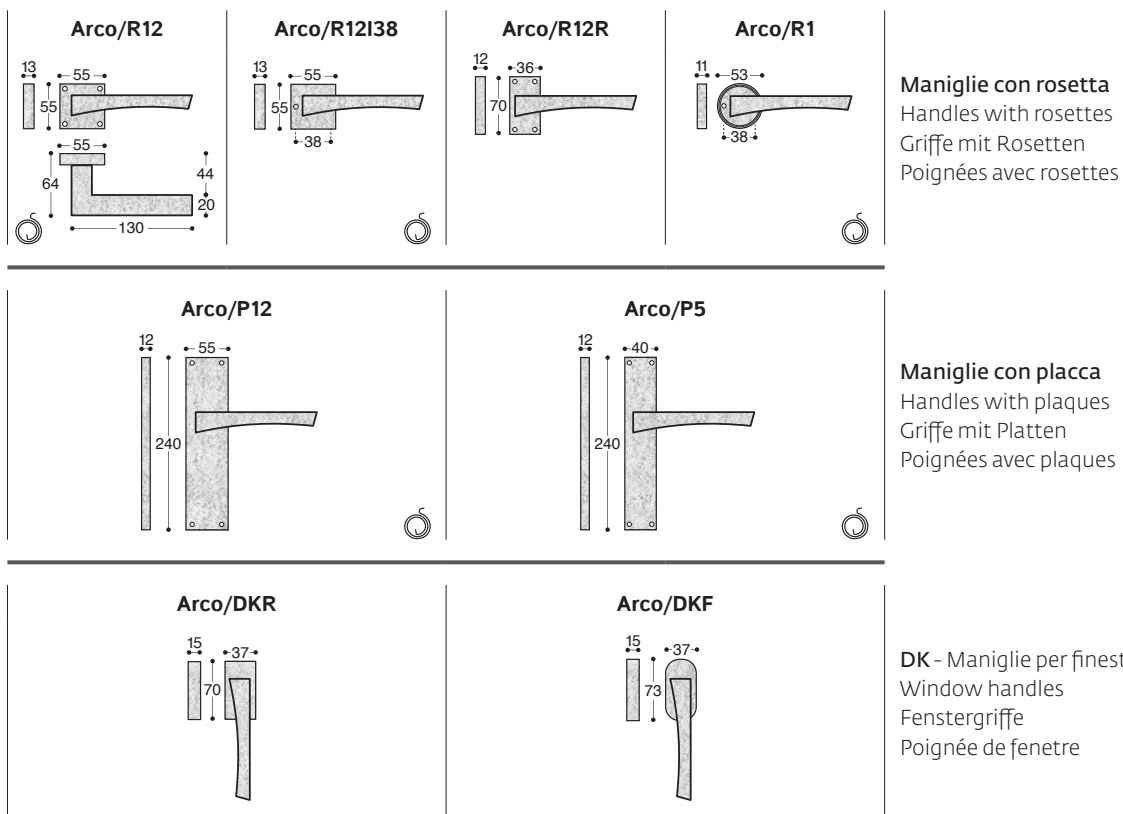

NB

AZ

VI

WB

AS

AI

OPW

BLK

RUB

RUW

⇒ pag. 144

BRONZE



Il segno di "Arco" diventa inconfondibile negli interni, il dinamismo della curva si accosta alle più differenti soluzioni architettoniche, da quelle classiche a quelle più contemporanee.

The "Arco" symbol becomes unmistakable in interior spaces, the dynamism of the curve can be matched with the most different architectural solutions, from classic to the most contemporary.

Das Zeichen "Arco" wird in Innenräumen unverwechselbar. Die Dynamik der Kurve wird mit den unterschiedlichsten architektonischen Lösungen kombiniert – von den klassischen bis zu den zeitgenössischen.

Le signe d'« Arc » devient unique dans les intérieurs, le dynamisme des courbes rapprochent les solutions architecturales les plus diverses, du classique au contemporain.

accessori Arco

Negli accessori la collezione Arco presenta due grandi maniglioni e una serie di manigliette. La dinamicità di questi particolari valorizza ulteriormente le realizzazioni in cui sono inserite.

the Arco accessories collection features two large handles and a series of smaller handles. The dynamism of these details further enhance the projects where they are inserted.

Das Zubehör der Kollektion Arco verfügt über zwei große Griffe und eine Reihe von kleinen Griffen. Die Dynamik dieser Arbeiten verleiht ihrer Umgebung einen zusätzlichen Wert.

Dans les accessoires, la collection Arco présente deux grands poignées de tirage et une série de poignées pour meuble. L'aspect dynamique de ces détails valorise ensuite les réalisations dans lesquelles elles sont insérées.



Arco-350

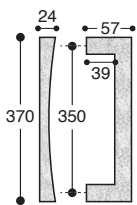

Arco-600

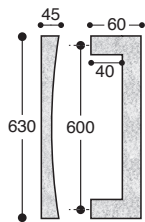

Maniglione
Pull handle
Türgriff
Tirant

Arco-102

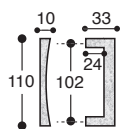

Arco-152

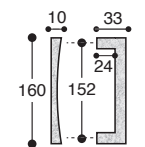

Maniglie per mobili
Furniture handles
Möbelgriffe
Poignée pour meubles



NB AZ VI WB AS AI OPW BLK RUB RUW

⇒ pag. 144

A photograph of a rustic dining room. The room features two large, square stone pillars on either side of the frame. The ceiling is made of large, rough-hewn stone slabs with a weathered, granite-like texture. The floor is composed of large, light-colored terracotta tiles. In the center, a dark wood dining table is set with white chairs. In the background, there is a fireplace mantel with a framed picture and some decorative items. A doorway leads to another room.

collezione Cosmo

La sua forma rigorosa viene arricchita da una superficie che ricorda una roccia granitica scalfita dal tempo. Ne deriva una sensazione di materia viva che riscalda gli arredi più contemporanei.

Its rigorous shape is enriched by a surface reminiscent of a granite rock scratched by time. The result is a feeling of living matter that warms up the most contemporary furnishings.

Ihre strenge Form wird durch eine Oberfläche bereichert, die an einen Granitfelsen erinnert, der von den Spuren der Zeit gekennzeichnet ist. Das Ergebnis ist ein Gefühl von lebendigem Material, das die modernste Einrichtung wärmer erscheinen lässt.

Sa forme rigoureuse est enrichie par une surface qui rappelle une roche en granit rayée par le temps. Il en résulte une sensation de matière vive qui réchauffe les décorations les plus contemporaines.

BRONZE

collezione Cosmo



M90/R12 - finish NB

<p>M90/R12</p>	<p>M90/R12I38</p>	<p>M90/R12R</p>	<p>Maniglie con rosetta Handles with rosettes Griffe mit Rosetten Poignées avec rosettes</p>	
<p>M90/P12</p>	<p>M90/P5</p>	<p>Po90-60/P12</p>	<p>Po90-60/P5</p>	<p>Maniglie con placca Handles with plaques Griffe mit Platten Poignées avec plaques</p>
<p>M90/DKR</p>	<p>Po90/R12</p>	<p>DK - Maniglie per finestra Window handles Fenstergriffe Poignée de fenetre</p> <p>Pomoli / Knobs / Knöpfe / Boutons</p>		



NB

AZ

VI

WB

AS

AI

OPW

BLK

RUB

RUW

⇒ pag. 144

BRONZE

Presenza di forte personalità che trasforma ogni apertura in un'esperienza sensoriale, oltre che visiva, senza tempo.

Strong presence that transforms every door into a timeless sensory and visual experience.

Diese Kollektion verfügt über eine starke Persönlichkeit, die jede Öffnung in ein zeitloses sensorisches und visuelles Erlebnis verwandelt.

Elle dégage une forte personnalité qui transforme chaque ouverture en une expérience sensorielle et visuelle intemporelle.



accessori Cosmo

La texture particolare della superficie di Cosmo si adatta perfettamente ai piccoli pomoli, alle manigliette e ai maniglioni, ottenendo l'effetto di un tutto coordinato.

The particular surface texture of the Cosmo accessories adapts perfectly to small knobs, small handles and large handles, thus providing a perfectly coordinated effect.

Die besondere Textur der Oberflächen von Cosmo ist perfekt für kleine und große Griffe geeignet und erzeugt einen koordinierten Effekt.

La texture particulière de la surface de Cosmo s'adapte parfaitement aux petits boutons, aux poignées pour meuble et aux poignées de tirant, en obtenant l'effet d'un ensemble coordonné.

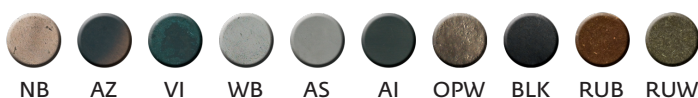
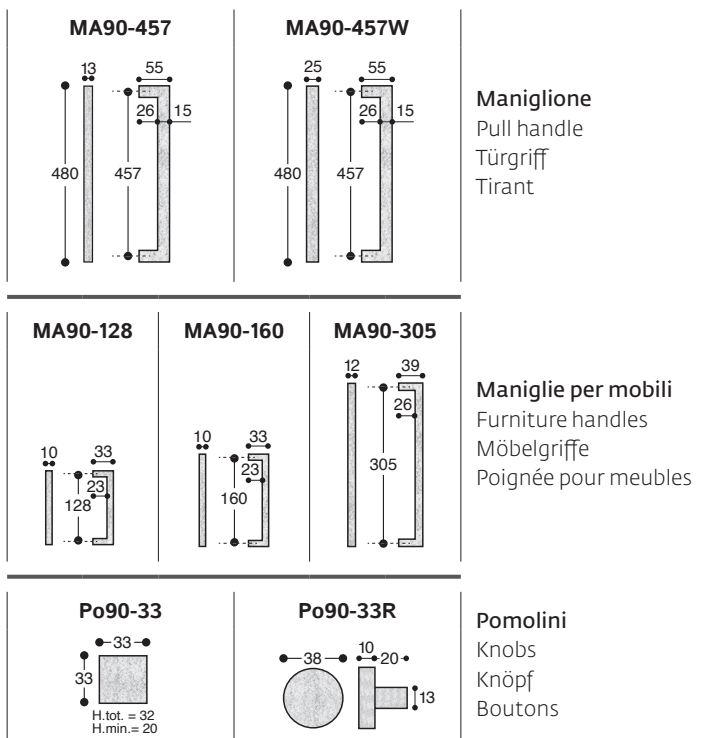

⇒ pag. 144



collezione La

Design sofisticato, carattere forte, si sviluppa sulla torsione del volume, sposando un concetto di dinamismo accentuato che rende "morbido" il metallo. Ideale per un'architettura moderna, minimalista.

Sophisticated design, strong character, it has been developed from a twist of the volume, marrying a concept of accentuated dynamism that makes the metal "soft". Ideal for modern, minimalist architecture.

Das raffinierte Design mit einem starken Charakter entwickelt sich aus der Torsion des Volumens und steht für ein Konzept der akzentuierten Dynamik, das das Metall „weich“ erscheinen lässt. Ideal für moderne, minimalistische Architektur.

Un design sophistiqué, un caractère fort, qui se développe sur la torsion du volume, en épousant un concept de dynamisme accentué qui rend « souple » le métal. Parfait pour une architecture moderne et minimaliste.

BRONZE

collezione La

design Fabrizio Cester



LA/R12SFV - finish OPW

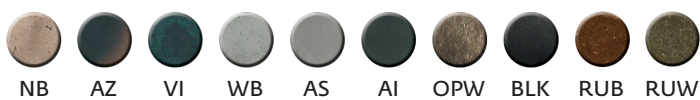
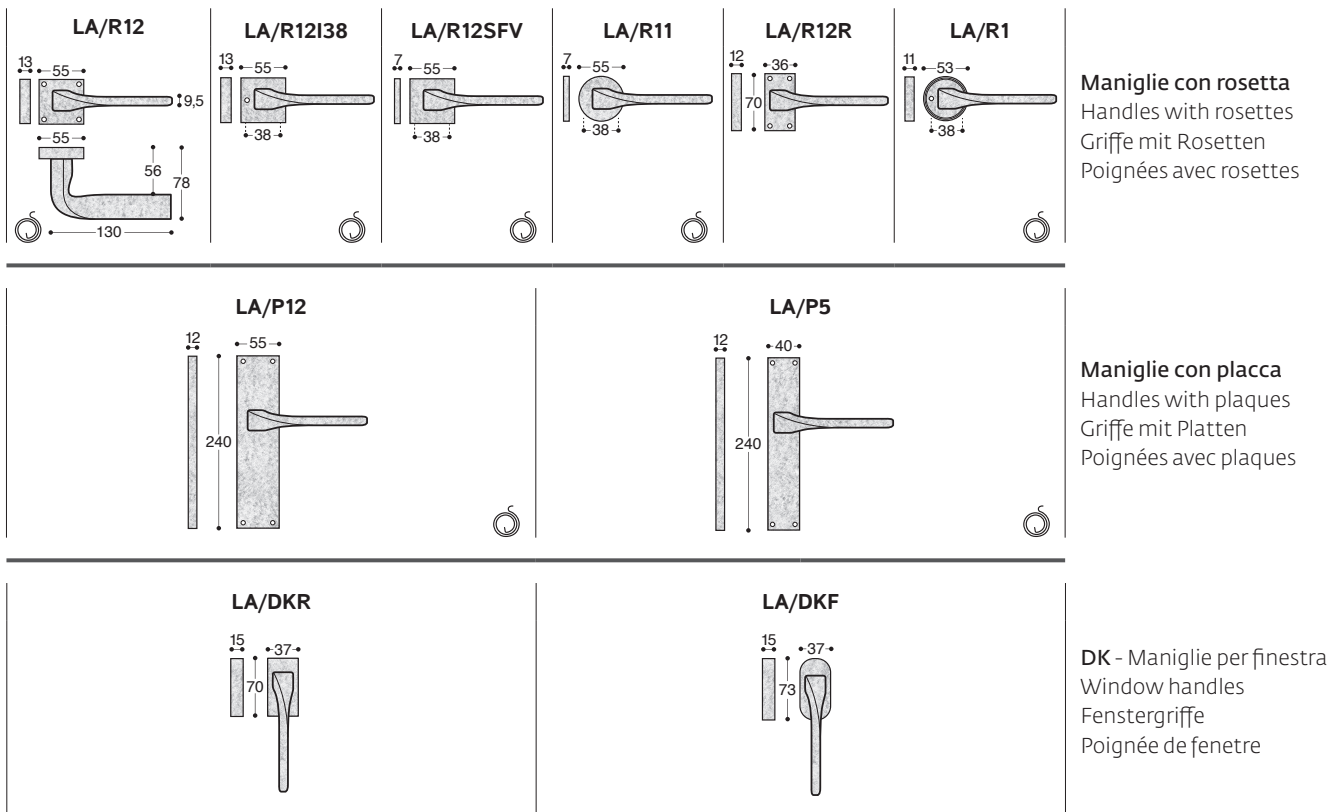

⇒ pag. 144

BRONZE



Grandi aperture fanno da perfetto contorno al dettaglio in bronzo che, con la sua scultorea torsione, le firma in un elegante nodo.

Large doors are the perfect outline for the bronze detail that, with its sculptural twisting, signs them in an elegant knot.

Große Türen sind ideal für das Bronzedetail, das mit seiner skulpturalen Torsion einen eleganten Knoten bildet.

De grandes ouvertures font office de contour parfait pour les détails en bronze qui, avec sa torsion sculpturale, les signent dans un nœud élégant.

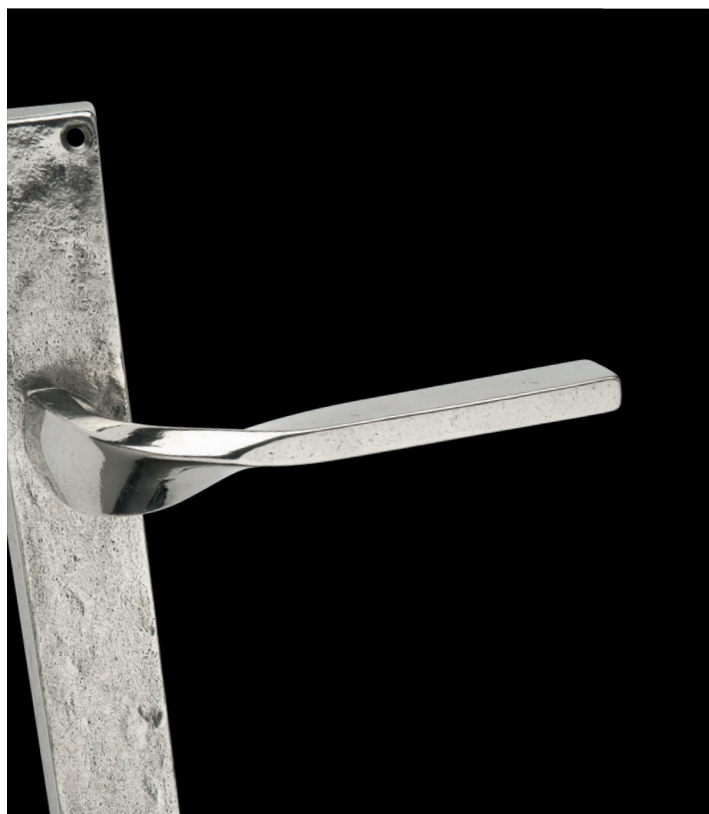

accessori La

Il gioco della torsione crea un effetto dinamico per mobili o piccoli componenti d'arredo sia nelle grandi che nelle piccole dimensioni.

The twisting theme creates a dynamic effect for furniture or small furnishing components in large and small sizes.

Das Spiel der Torsion erzeugt einen dynamischen Effekt für Möbel oder kleine Möbelteile in großen und kleinen Größen.

Le jeu de torsions crée un effet dynamique pour les meubles ou petits composants de décoration en grandes et en petites dimensions.

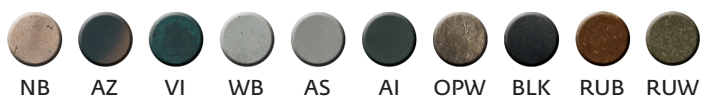
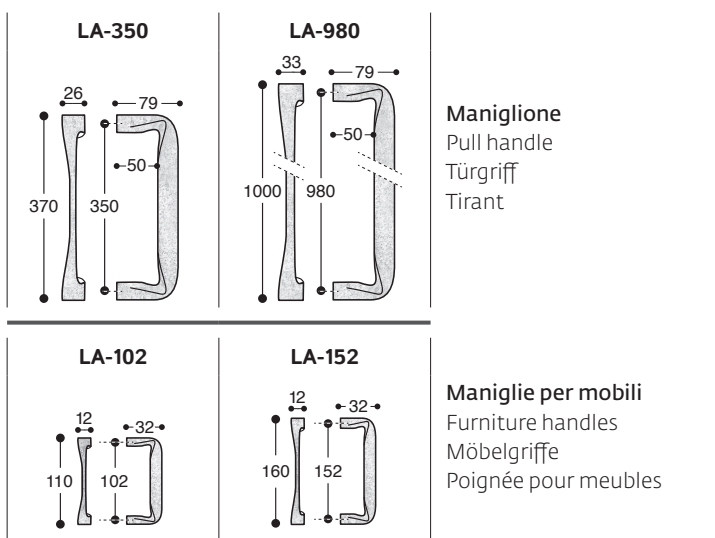

⇒ pag. 144



collezione Langhe

La forma data da un volume semplice e rettangolare ricorda vecchie prese di utensili in legno, che donano a questa linea un'inaspettata affinità per gli ambienti rustici.

The shape given by a simple and rectangular volume recalls old wooden tool presses, This gives this line an unexpected affinity for rustic environments.

Die Form, die durch ein einfaches_ rechteckiges Volumen entsteht, erinnert an alte hölzerne Werkzeuggriffe und verleiht dieser Produktlinie eine unerwartete Verbundenheit mit rustikaler Umgebung.

La forme donnée par un volume simple et rectangulaire rappelle de vieilles prises d'outils en bois, qui apportent à cette ligne une affinité inattendue pour les environnements rustiques.



BRONZE

collezione Langhe

design Studio Parisotto + Formenton



M93/R11 - finish AI

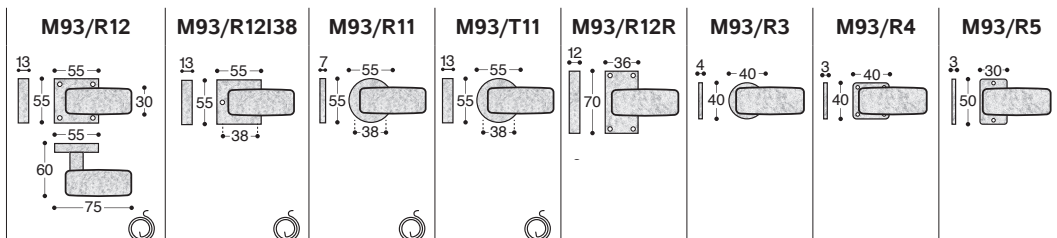

Maniglie con rosetta
 Handles with rosettes
 Griffe mit Rosetten
 Poignées avec rosettes

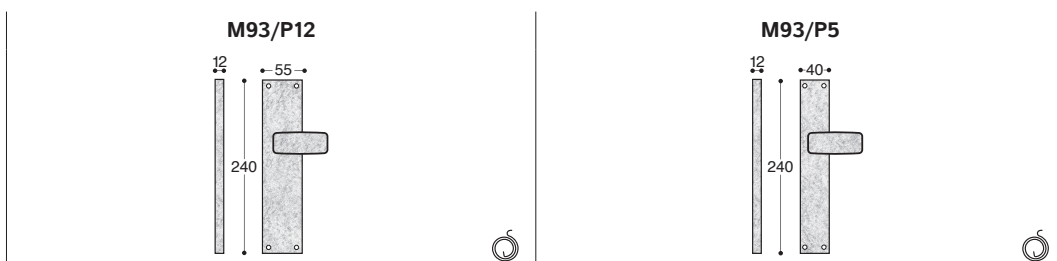

Maniglie con placca
 Handles with plaques
 Griffe mit Platten
 Poignées avec plaques

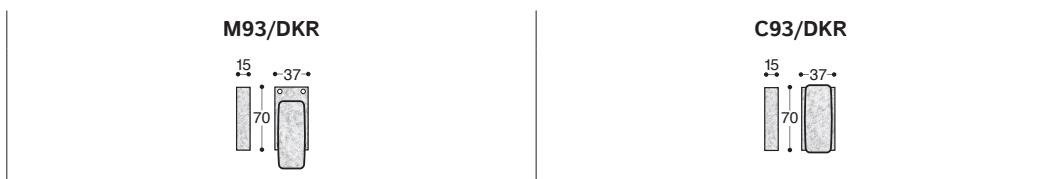

DK - Maniglie per finestra
 Window handles
 Fenstergriffe
 Poignée de fenetre

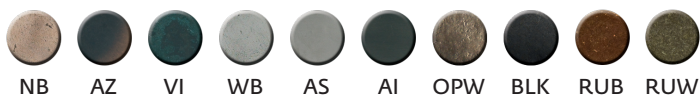

⇒ pag. 144



collezione Liscia

Rigorosa e liscia, senza fronzoli, un esempio di forma pura che manifesta in tutta la sua essenza la forza interiore del bronzo.

Rigorous and smooth, without frills, an example of pure form that manifests the inner strength of bronze in all its essence.

Streng und glatt, ohne Schnörkel, ein Beispiel für die reine Form, die in ihrem ganzen Wesen die innere Kraft der Bronze zum Ausdruck bringt.

Rigoureuse et lisse, sans fioritures, un exemple de forme pure qui manifeste dans toute sa nature la force intérieure du bronze.

BRONZE

collezione **Liscia**



M92/R12 - finish NB

<p>M92/R12</p>	<p>M92/R12I38</p>	<p>M92/R12SFV</p>	<p>M92/R12R</p>	<p>Maniglie con rosetta Handles with rosettes Griffe mit Rosetten Poignées avec rosettes</p>
<p>M92/P12</p>	<p>M92/P5</p>	<p>Po12-P12</p>	<p>Po12-P5</p>	<p>Maniglie con placca Handles with plaques Griffe mit Platten Poignées avec plaques</p>
<p>M92/DKR</p>	<p>Po12/R12</p>	<p>DK - Maniglie per finestra Window handles Fenstergriffe Poignée de fenetre</p> <p>Pomoli / Knobs / Knöpfe / Boutons</p>		



NB AZ VI WB AS AI OPW BLK RUB RUW → pag. 144

BRONZE



Liscia, una presenza sobria all'interno degli ambienti,
con quel pizzico di calore anche negli arredi più
eclettici.

Smooth, a sober presence inside the rooms, with that
pinch of warmth even in the most eclectic décor.

Liscia, eine nüchterne Ausstrahlung in den Räumen,
mit diesem Hauch von Wärme, selbst bei einer
eklektischen Einrichtung.

Lisse, une présence sobre de l'environnement, avec
cette pincée de chaleur même dans les ameublements
les plus variés.

accessori **Liscia**

Pomoli, maniglie e maniglioni legati da un'identica idea di semplicità e linearità, dettagli per un arredo senza tempo.

Knobs, small handles and large handles bound by an identical idea of simplicity and linearity, details for timeless furniture.

Knäufe, kleine und große Griffe, bringen eine Vorstellung von Einfachheit und Linearität zum Ausdruck. Details für eine zeitlose Einrichtung.

Boutons, poignées pour meuble et poignées de tirage liés par une idée similaire de simplicité et de linéarité, des détails pour une décoration intemporelle.

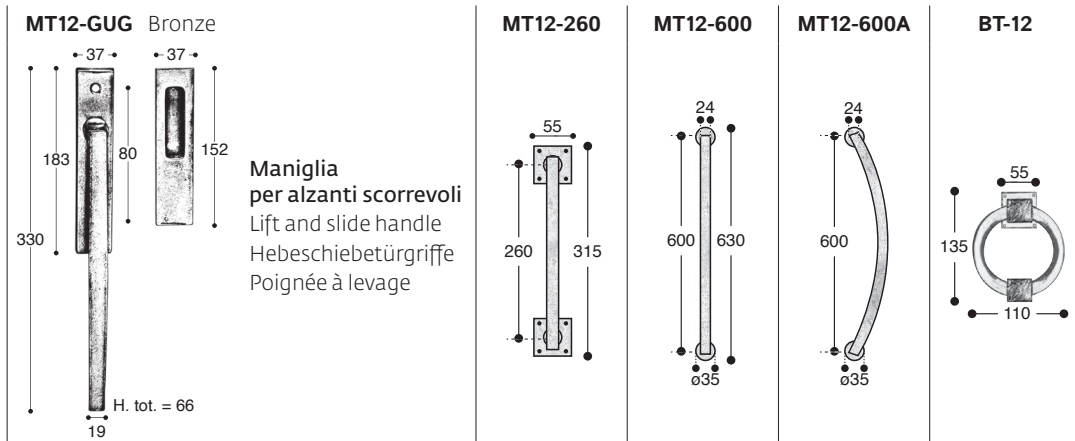

Maniglioni
 Pull handles
 Türgriff
 Tirants

Battente
 Doorknocker
 Türklopfer
 Heurtoir

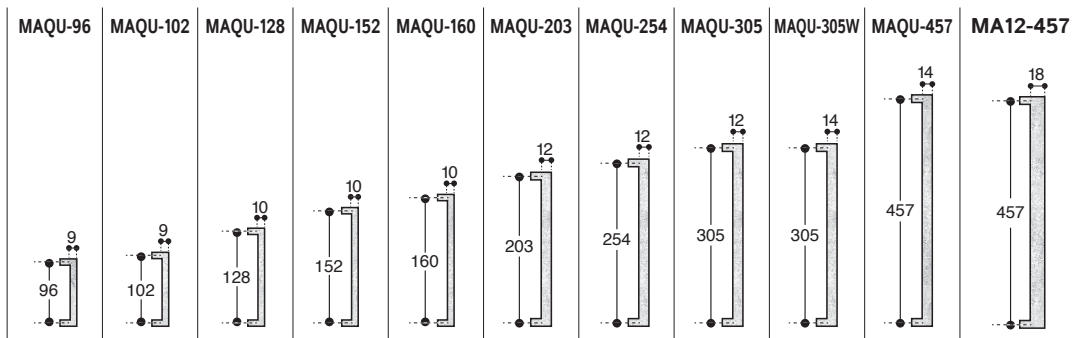

Maniglie per mobili
 Furniture handles
 Möbelgriffe
 Poignée pour meubles

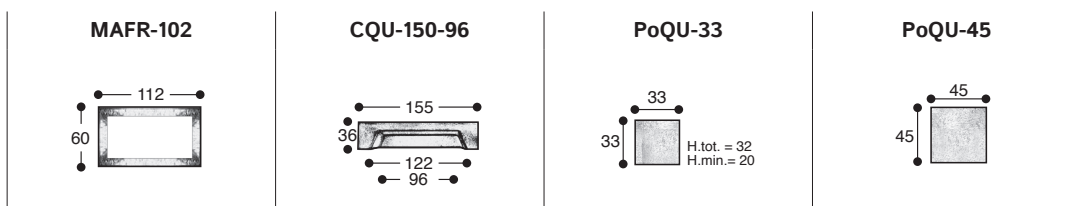

Maniglie per mobili
 Furniture handles
 Möbelgriffe
 Poignée pour meubles

Pomolini / Knobs
 Knöpf / Boutons



NB AZ VI WB AS AI OPW BLK RUB RUW

⇒ pag. 144



collezione Milano

Disegno tradizionale, con la sua sezione quadrata, Milano riprende le forme semplici ma decise dei primi del Novecento. Essenziale, la maniglia trova un'ottimale collocazione tra arredi tradizionali, in ambienti classici.

Traditional design, with its square section, Milano takes up the simple but decisive shapes of the early twentieth century. Essential, the handle finds an optimal placement among traditional furnishings, in classic environments.

Traditionelles Design mit seinem quadratischen Profil. Milano erinnert an die einfachen, aber entschlossenen Formen des frühen zwanzigsten Jahrhunderts. Der unverzichtbare Griff findet einen optimalen Platz unter traditionellen Möbeln in klassischen Umgebungen.

Dessin traditionnel, avec sa section carrée, Milan reprend les formes simples mais décidées du début du vingtième siècle. Essentielle, la poignée de porte trouve un emplacement optimal parmi les décorations traditionnelles, dans des environnements au style classique.

BRONZE

collezione Milano

design Ivo Pellegrini



Milano/R1 - finish VI

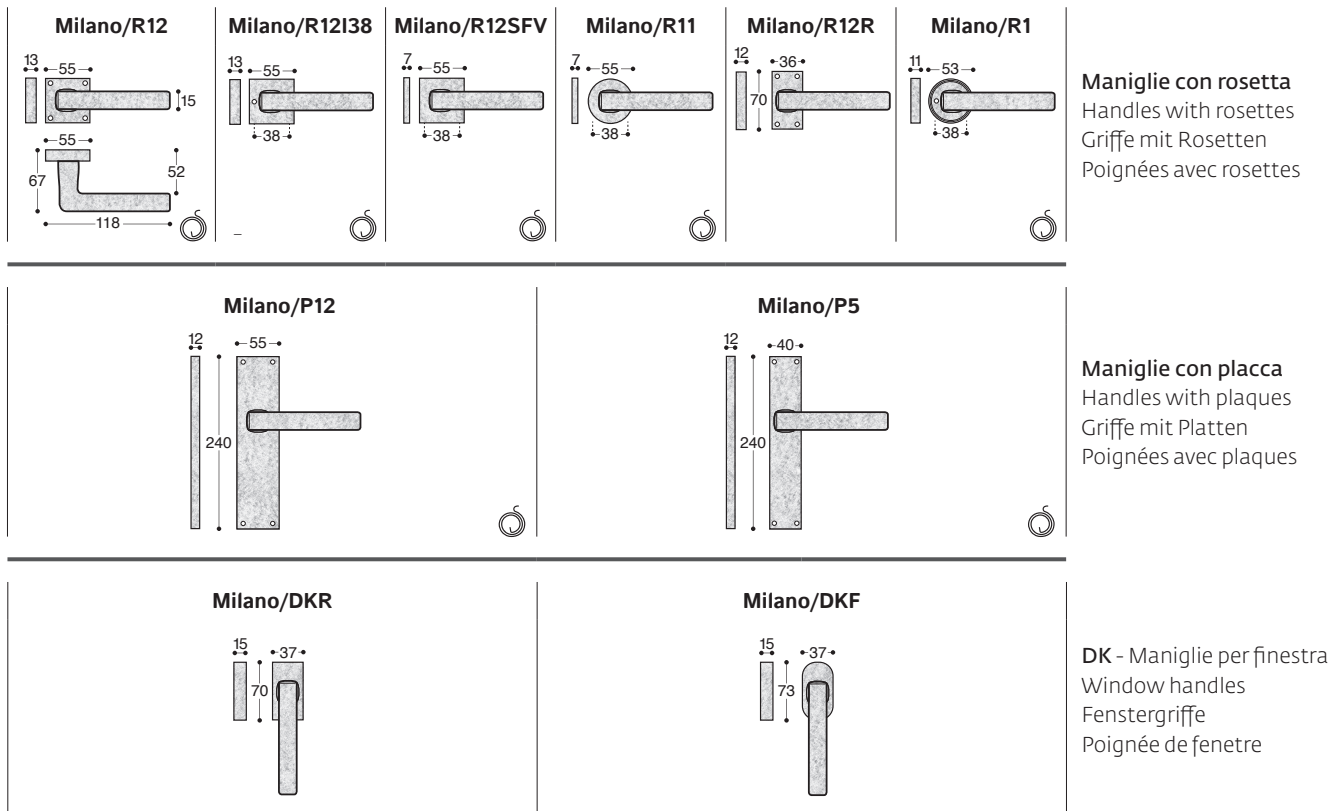

⇒ pag. 144

BRONZE



Entra in modo disinvolto negli spazi metropolitani, trovandosi a proprio agio in ogni contesto, dall'abitazione all'ufficio.

It casually meets metropolitan spaces, and it fits comfortably in every context, from the home to the office.

Lässig wirkt er in großstädtischen Räumen und fühlt sich in jeder Umgebung wohl - von der Wohnung bis zum Büro.

Elle s'insère de manière désinvolte dans les espaces métropolitains, en se trouvant à son aise dans chaque contexte, de l'habitation au bureau.



accessori Milano

Maniglie per mobili o piccoli complementi d'arredo che stupiscono per la loro classicità ma al tempo stesso permeano il contemporaneo.

Handles for furniture or small furnishing accessories that amaze for their classicism but, at the same time, they can permeate the contemporary style.

Griffe für Möbel oder kleine Einrichtungsaccessoires, die immer wieder durch ihre klassische Beschaffenheit beeindrucken und gleichzeitig zeitgenössisch sind.

Des poignées pour meubles ou de petits compléments de décoration qui étonnent par leur aspect classique mais qui en même temps imprègnent le contemporain.



MtMILANO-221

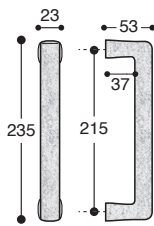

Maniglione
Pull handle
Türgriff
Tirant

MIL128

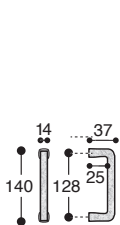

MIL160

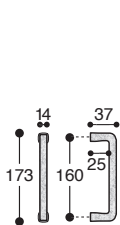

MIL320

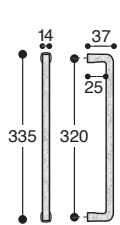

MIL457W

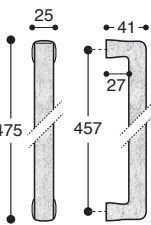

Maniglie per mobili
Furniture handles
Möbelgriffe
Poignée pour meubles

MIL-38

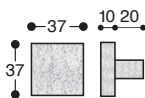

MIL-38R

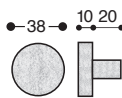

Pomolini
Knobs
Knöpfe
Boutons



NB AZ VI WB AS AI OPW BLK RUB RUW

⇒ pag. 144



collezione Onda

Le increspature della superficie del mare ispirano questa collezione, mossa da un carattere impetuoso e personale.



The ripples of the sea surface inspire this collection, moved by an impetuous and personal character.

Die Wellen der Meeresoberfläche inspirieren diese Kollektion, die von einem ungestümen und persönlichen Charakter bewegt wird.

Les ondulations de la surface de la mer inspirent cette collection, qui est caractérisée par un caractère impétueux et personnel.

BRONZE

collezione Onda



M91/R12 - finish NB

<p>M91/R12</p>	<p>M91/R12I38</p>	<p>M91/R12R</p>	<p>Maniglie con rosetta Handles with rosettes Griffe mit Rosetten Poignées avec rosettes</p>	
<p>M91/P12</p>	<p>M91/P5</p>	<p>Po91/P12</p>	<p>Po91/P5</p>	<p>Maniglie con placca Handles with plaques Griffe mit Platten Poignées avec plaques</p>
<p>M91/DKR</p>	<p>Po91/R12</p>	<p>DK - Maniglie per finestra Window handles Fenstergriffe Poignée de fenetre</p> <p>Pomoli / Knobs / Knöpfe / Boutons</p>		



NB

AZ

VI

WB

AS

AI

OPW

BLK

RUB

RUW

⇒ pag. 144

BRONZE



L'essenza di questa maniglia evoca una natura forte, un carattere deciso, adatta per ambienti coinvolgenti e di forte personalità.

The essence of this handle evokes a strong nature, a decisive character, suitable for engaging environments with a strong personality.

Das Wesen dieses Griffs beschwört eine starke Natur herauf und hat einen entschlossenen Charakter, der sich für ansprechende Umgebungen mit einer starken Persönlichkeit eignet.

La nature de cette poignée de porte évoque une nature forte, un caractère décidé, adapté aux environnements captivants et à la forte personnalité.



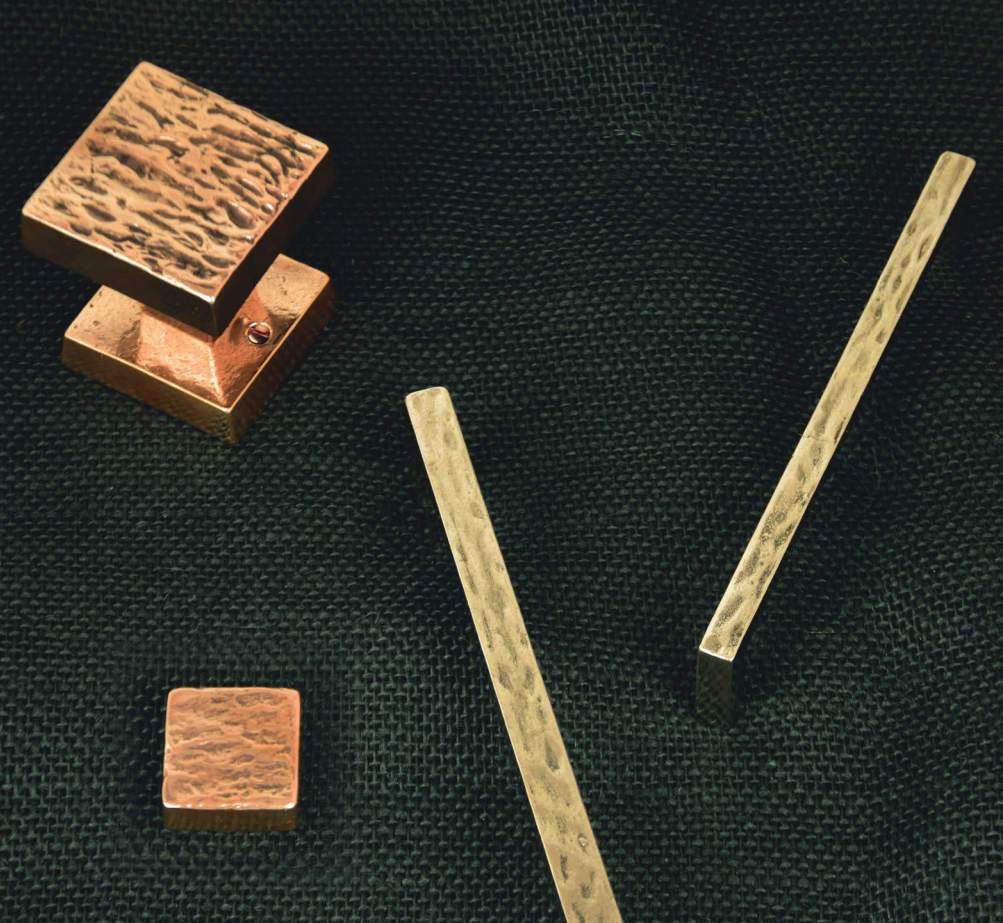

accessori Onda

La forza della superficie Onda si inserisce perfettamente in mobili e complementi d'arredo più contemporanei, i maniglioni diventano invece protagonisti in grandi aperture.

The strength of the Onda surface fits perfectly into more contemporary furniture and furnishing accessories, while the handles become protagonists in large doors.

Die Stärke der Onda-Oberfläche passt perfekt zu zeitgenössischeren Möbeln und Einrichtungsaccessoires, während die Griffe im Mittelpunkt großer Türen stehen.

La force de la surface Onda s'insère parfaitement dans les meubles et compléments de décoration les plus contemporains et les poignées de tirage deviennent par contre des protagonistes dans les grandes ouvertures.

MA91-128	MA91-160	MA91-305	Maniglie per mobili Furniture handles Möbelgriffe Poignée pour meubles
Po91-33			Pomolini Knobs Knöpfe Boutons

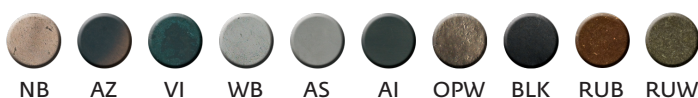

⇒ pag. 144



collezione Quadra

Il bronzo esalta l'essenza di questa tradizionale forma quadra che dà carattere a questo modello, che fa della semplicità la sua forza.

Bronze enhances the essence of this traditional square shape that gives character to this model, which makes simplicity its strength.

Bronze unterstreicht das Wesen dieser traditionellen quadratischen Form, die diesem Modell Charakter verleiht und die Einfachheit zu seiner Stärke macht.

Le bronze exalte l'essence de cette forme carré traditionnelle qui donne du caractère à ce modèle, qui fait de la simplicité sa force.

BRONZE

collezione Quadra



M12/R12 - finish WB

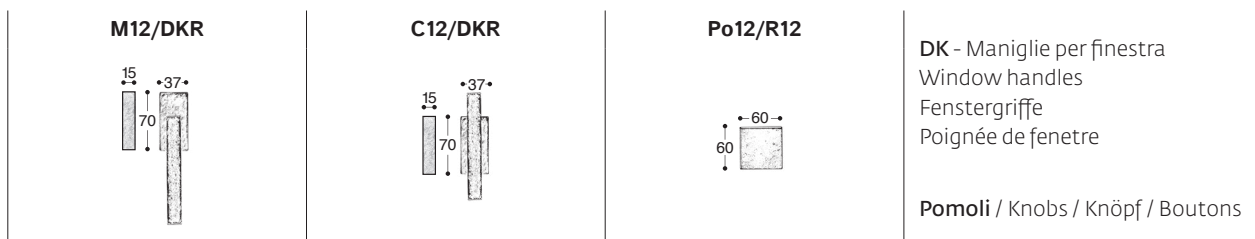
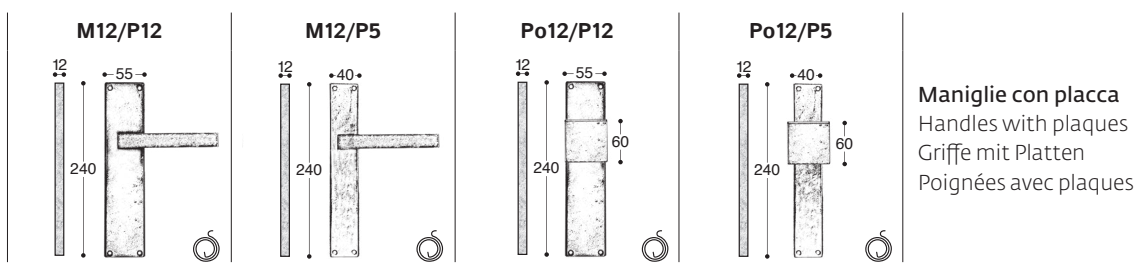
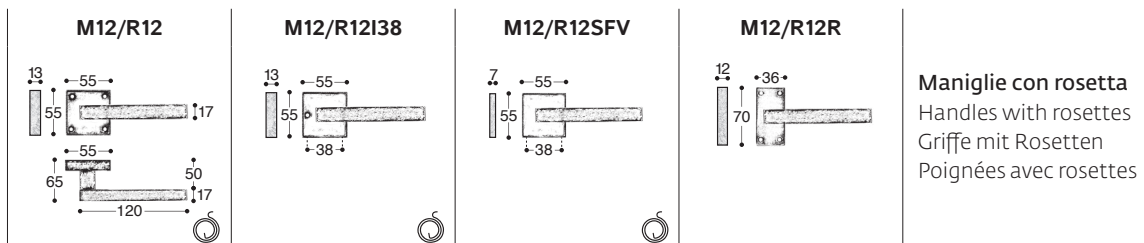

⇒ pag. 144

BRONZE



Pur non disdegnando ambienti più eclettici, quelli dallo spirito sobrio sembrano essere l'abbinamento ideale per Quadra.

While not disdaining more eclectic environments, sober spaces seem to be the ideal match for Quadra.

Obwohl sie auch in eine eklektische Umgebung passt, scheinen nüchterne Räume die ideale Ergänzung für Quadra zu sein.

Tout en s'adaptant aux environnements les plus divers, l'esprit sobre du modèlz Quadra semble être le complément idéal.



accessori Quadra

Un grande classico, che si esprime in una collezione completa per l'arredamento e le grandi porte, a proprio agio in ogni contesto.

A great classic, expressed in a complete collection for furniture and large doors, at ease in every context.

Ein Klassiker, der in einer kompletten Kollektion für Möbel und große Türen zum Ausdruck kommt und in jede Umgebung passt.

Un grand classique qui s'exprime dans une collection complète pour l'ameublement et les grandes portes, à l'aise dans toutes les situations.

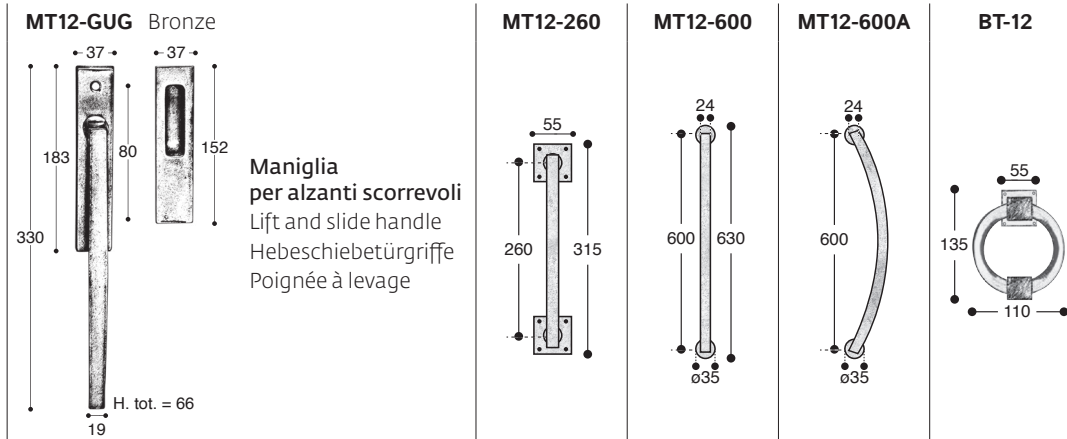

Maniglioni
 Pull handles
 Türgriff
 Tirants

Battente
 Doorknocker
 Türklopfer
 Heurtoir

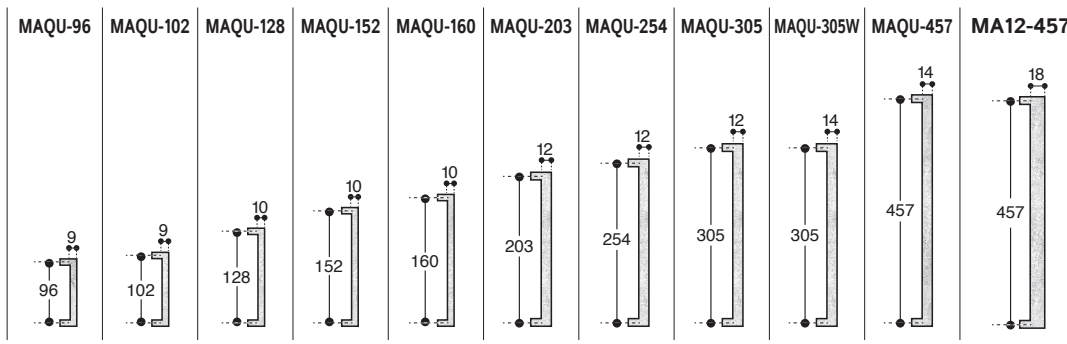

Maniglie per mobili
 Furniture handles
 Möbelgriffe
 Poignée pour meubles

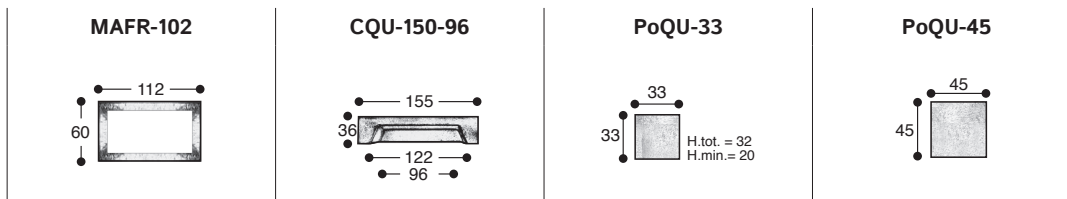

Maniglie per mobili
 Furniture handles
 Möbelgriffe
 Poignée pour meubles

Pomolini / Knobs
 Knöpfe / Boutons

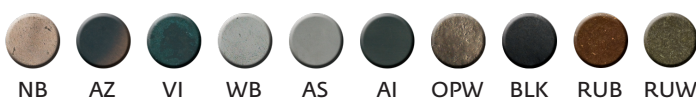

⇒ pag. 144





collezione bronzo

Giara Art design

Lo spirito autentico di una maestria artigianale classica e senza tempo. Disegni, forme e colori sono perfetti corollari a collezioni in cui il bronzo è protagonista con il suo fascino e la sua forza interiore.

Giara Art design

Authentic spirit of a classic and timeless craftsmanship. Designs, shapes and colors are perfect corollaries in collections where bronze is the protagonist with its charm and inner strength.

Giara Art design

Es verkörpert den authentischen Geist einer klassischen und zeitlosen Handwerkskunst. Design, Formen und Farben passen perfekt zu Kollektionen, in deren Mittelpunkt Bronze mit seinem Charme und seiner inneren Stärke steht.

Giara Art design

Esprit authentique d'une maîtrise artisanale classique et intemporelle. Les dessins, les formes et les couleurs sont des compléments parfaits à des collections où le bronze est l'élément principal avec son charme et sa force intérieure.



collezione **Chemin de Fer**

C'è tutto il fascino della prima locomozione a vapore dietro queste piccole leve, pronte ad azionare l'immaginario per un nuovo viaggio architettonico.

Behind these small levers, there is all the charm of the first steam locomotives, ready to expand the imagination for a new architectural journey.

Hinter diesen kleinen Hebeln steckt der ganze Charme der ersten Dampflokomotive, der die Phantasie zu einer neuen architektonischen Reise anregen soll.

Il y a tout le charme de la première locomotive à vapeur derrière ces petits leviers, prêts à actionner l'imaginaire pour un nouveau voyage architectural.



collezione Chemin de Fer

Giara Art design



M8/R3 - finish AI

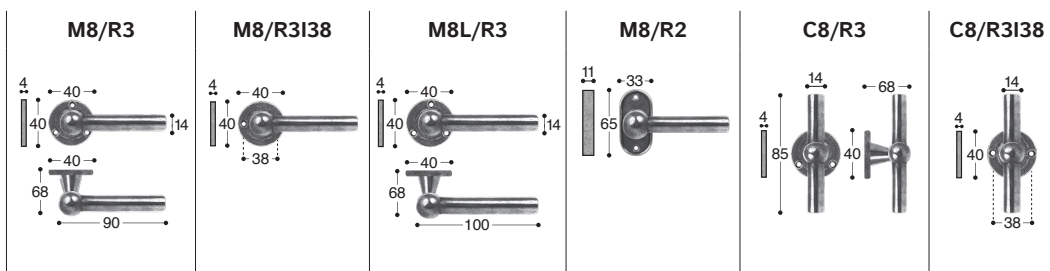

Maniglie con rosetta
 Handles with rosettes
 Griffe mit Rosetten
 Poignées avec rosettes

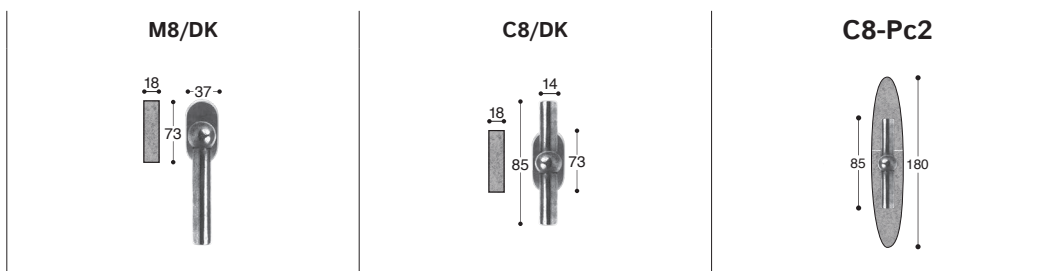

DK - Maniglie per finestra
 Window handles
 Fenstergriffe
 Poignée de fenetre



NB

AZ

VI

WB

AS

AI

OPW

BLK

BRI

RUB

RUW

⇒ pag. 144



Le piccole leve incontrano aperture
che si affacciano su paesaggi pieni di storia
ed emozione.

The small levers meet doors that overlook
landscapes full of history and emotion.

Kleine Hebel für Türen, durch die man
auf Landschaften voller Geschichte und
Emotionen blickt.

Les petits leviers rencontrent des ouvertures
qui donnent sur des paysages riches en
histoire et émotion.

accessori Chemin de Fer

Una collezione particolarmente ricca di accessori per la Chemin de Fer: in ognuna ritroviamo il carattere deciso di questa linea.

The Chemin de Fer accessories collection is particularly rich: in each model, we find the decisive character of this line.

Eine Kollektion mit besonders viel Zubehör ist Chemin de Fer: - überall finden wir den entschlossenen Charakter dieser Kollektion.

Une collection particulièrement riche en accessoires : dans chacune d'entre elles nous retrouvons le caractère particulier de cette ligne.



MT8-224

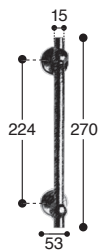

MT8-300A

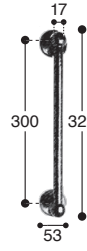

MT8-300B

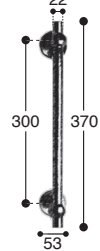

Maniglioni
Pull handles
Türgriff
Tirants

Maniglia per alzanti scorrevoli
Lift and slide handle
Hebeschiebetürgriffe
Poignée à levage

MA8-64



MA8-96



MA8-128



MA8-224

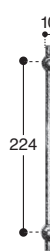

MA8-384

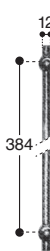

MA8-512

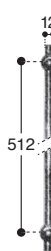

Maniglie per mobili
Furniture handles
Möbelgriffe
Poignée pour meubles

MT8-GUG Bronze

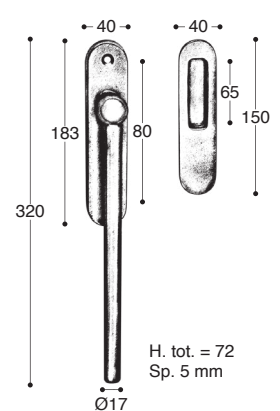

Po8-45

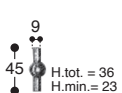

Po8-55

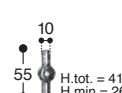

Po8-25



AP-8



Pomolini
Knobs
Knöpfe
Boutons



NB

AZ

VI

WB

AS

AI

OPW

BLK

BRI

RUB

RUW

⇒ pag. 144

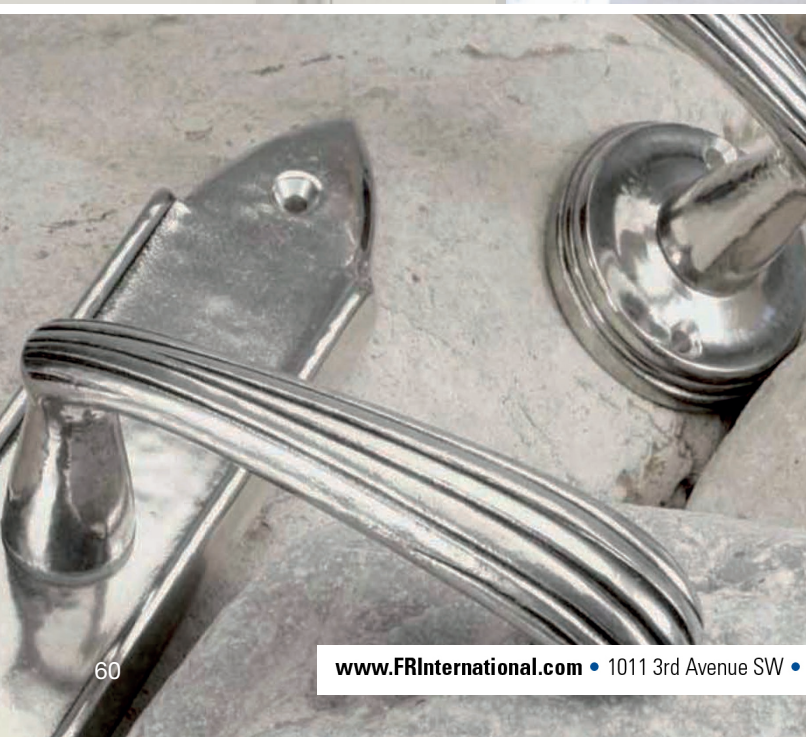

collezione **Conchiglia**

La forma classica della conchiglia ispira questa collezione, fascino innato ispirato dalla natura.

The classic shape of the shell inspires this collection, an innate charm inspired by nature.

Die klassische Form der Muschel inspiriert diese Kollektion. Der natürliche Zauber der Natur.

La forme classique de la conchiglia inspire cette collection, charme inné inspiré par la nature.



collezione Conchiglia

Giara Art design



M7/R1 - finish WB

M7/R1

Maniglie con rosetta
Handles with rosettes
Griffe mit Rosetten
Poignées avec rosettes

<p>M7/P1</p>	<p>M7/P2</p>	<p>M7/P3</p>	<p>M7/P3-35</p>	<p>M7/P4</p>	<p>M7/P6</p>
---------------------	---------------------	---------------------	------------------------	---------------------	---------------------

Maniglie con placca
Handles with plaques
Griffe mit Platten
Poignées avec plaques

M7/DK

DK - Maniglie per finestra
Window handles
Fenstergriffe
Poignée de fenetre



⇒ pag. 144



L'eleganza della conchiglia ed il colore argenteo del bronzo bianco creano ambienti di sublime atmosfera.

The elegance of the shell and the silvery color of white bronze create environments with a sublime atmosphere.

Die Eleganz der Muschel und die silbrige Farbe der weißen Bronze lassen Räume mit einer besonderen Atmosphäre entstehen.

L'élégance de la conchiglia et la couleur argentée du bronze blanc créent des environnements avec une atmosphère sublime.



accessori Conchiglia

L'eleganza di questa collezione si accentua con gli accessori che ne esaltano la leggerezza e l'armonia.

The elegance of this collection is accentuated with accessories that enhance its lightness and harmony.

Die Eleganz dieser Kollektion kommt in dem Zubehör zum Ausdruck, das Leichtigkeit und Harmonie entstehen lässt.

L'élégance de cette collection est soulignée par les accessoires qui en exaltent la légèreté et l'harmonie.

MT7-GUG

Maniglia per alzanti scorrevoli
 Lift and slide handle
 Hebeschiebetürgriffe
 Poignée à levage

<p>Ma5T-64</p>	<p>Ma5T-96</p>	<p>Ma5T-160</p>	<p>Ma5T-224</p>	
<p>Po50-35</p>	<p>Po50-28</p>	<p>Po5T-38</p>	<p>Po5T-33</p>	<p>Po5T-23</p>

Maniglie per mobili
 Furniture handles
 Möbelgriffe
 Poignée pour meubles

Pomolini / Knobs
 Knöpf / Boutons



NB AZ VI WB AS AI OPW BLK BRI RUB RUW ⇨ pag. 144



collezione **Florenza**

Florenza, esempio di design classico che può arricchire anche ambienti contemporanei.

Florenza collection represents a classic design which can also enrich a contemporary environment.

Florenza ist ein Beispiel für classisches Design, das auch eine zeitgenössische Umgebung bereichert.

Florenza, design classique qui permet d'enrichir également un environnement contemporain.





collezione **Florenza**

Giara Art design



M1/R1 - finish **WB**

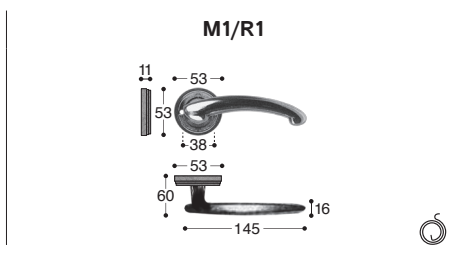

Maniglie con rosetta
Handles with rosettes
Griffe mit Rosetten
Poignées avec rosettes

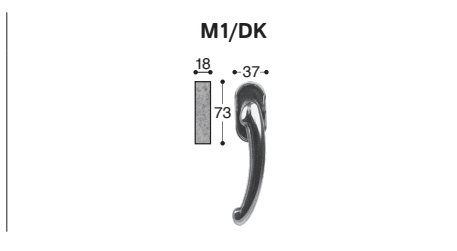

DK - Maniglie per finestra
Window handles
Fenstergriffe
Poignée de fenetre

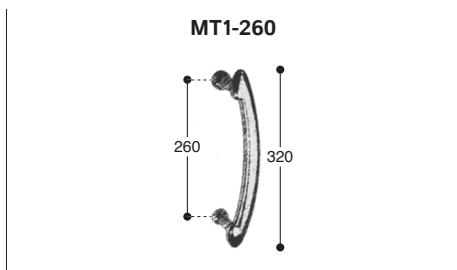

Maniglione
Pull handle
Türgriff
Tirant

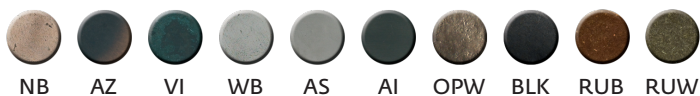

⇒ pag. 144



collezione Gotica

Gotica si presenta come una collezione dinamica nelle forme e al contempo rigorosa, un esempio felice di disegno classico che arricchisce anche un ambiente contemporaneo.

The Gotica collection presents itself as a dynamic shape that at the same time is rigorous. A happy example of classic design that can also enrich a contemporary environment.

Gotica ist eine Kollektion mit dynamischen Formen, die gleichzeitig streng ist. Sie ist ein Beispiel für klassisches Design, das auch eine zeitgenössische Umgebung bereichert.

Gotica se présente comme une collection dynamique par ses formes et en même temps rigoureuse, un exemple de design classique qui permet d'enrichir également un environnement contemporain.





collezione Gotica

Giara Art design



M3/R1 - finish AZ

M3/R1

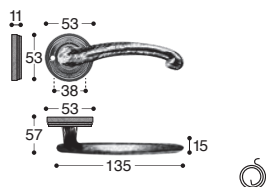

Maniglie con rosetta
Handles with rosettes
Griffe mit Rosetten
Poignées avec rosettes

M3/P1

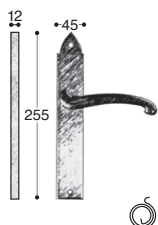

M3/P2

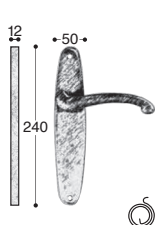

M3/P3

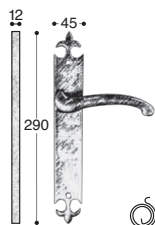

M3/P3-35

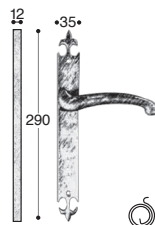

M3/P4

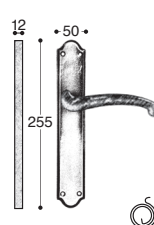

M3/P6

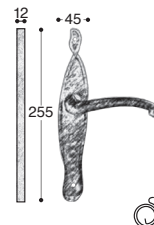

Maniglie con placca
Handles with plaques
Griffe mit Platten
Poignées avec plaques

M3/DK

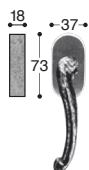

DK - Maniglie per finestra
Window handles
Fenstergriffe
Poignée de fenetre



NB

AZ

VI

WB

AS

AI

OPW

BLK

RUB

RUW

⇒ pag. 144



Austera e ricca di storia,
Gotica si riflette nelle architetture
di un glorioso passato.

Austere and rich in history, Gótica is
reflected in the architectural styles of a
glorious past.

Strenge und geschichtsträchtig
orientiert sich die Kollektion Gótica
an der Architektur einer glorreichen
Vergangenheit.

Austère et riche en histoire, Gótica se
reflète dans les architectures d'un passé
glorieux.



accessori Gotica

Gli accessori di Gotica si caratterizzano per la loro linea arcuata che viene delimitata da due piccole ali, esempio delle più antiche lavorazioni del metallo.

The accessories in the Gotica line are characterized by their arched line that is bordered by two small wings, an example of the ancient metalworking.

Das Zubehör von Gotica zeichnet sich durch eine geschwungene Linie aus, die von zwei kleinen Flügeln begrenzt wird. Ein Beispiel für die ältesten Methoden der Metallverarbeitung.

Les accessoires de Gotica se caractérisent par leur ligne arquée qui est délimitée par deux petites ailes, exemple des plus anciennes transformations du métal.

MT1-260

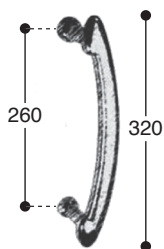

Maniglione
Pull handle
Türgriff
Tirant



NB

AZ

VI

WB

AS

AI

OPW

BLK

BRI

RUB

RUW

⇒ pag. 144



collezione **Impero**

Le colonne dell'antico impero romano hanno ispirato questo prestigioso modello.

The columns of the ancient Roman Empire inspired this prestigious model.

Die Säulen des Römischen Reiches inspirierten dieses prestige trächtige Modell.

Les colonnes de l'ancien empire romain ont inspiré ce modèle prestigieux.



collezione Impero

Giara Art design



M13/R1 - finish NB

M13/R1

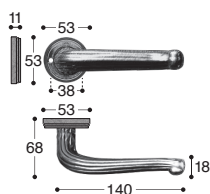

Maniglie con rosetta
Handles with rosettes
Griffe mit Rosetten
Poignées avec rosettes

M13/DK

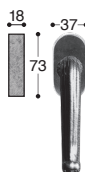

DK - Maniglie per finestra
Window handles
Fenstergriffe
Poignée de fenetre



NB

AZ

VI

WB

AS

AI

OPW

BLK

RUB

RUW

⇒ pag. 144



collezione **Mossa**

Una linea di ispirazione primitiva, come un'impronta di una mano su una pietra logorata dal tempo. Un esempio di un segno primordiale dove il bronzo ne esalta il suo pieno significato.

A line of primitive inspiration, like an imprint of a hand on a stone worn down by time. An example of a primordial sign where bronze enhances its full meaning.

Eine Produktlinie mit primitiver Inspiration, wie ein Handabdruck auf einem von der Zeit abgenutzten Stein. Ein Beispiel für ein ursprüngliches Zeichen, mit dem Bronze die ganze Bedeutung zeigt.

Une ligne d'inspiration primitive, comme l'empreinte d'une main sur une pierre usée par le temps. Un exemple d'un signe primordial dans lequel le bronze permet d'en exalter pleinement sa valeur.





collezione Mossa

Giara Art design



M4/R1 - finish AZ

M4/R1

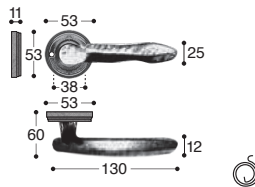

Maniglie con rosetta
 Handles with rosettes
 Griffe mit Rosetten
 Poignées avec rosettes

M4/P1

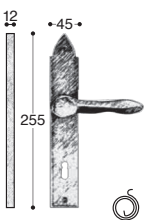

M4/P2

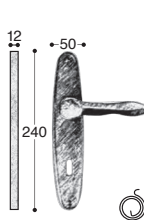

M4/P3

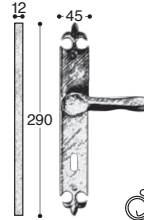

M4/P3-35

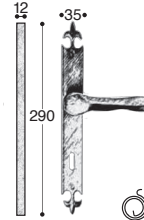

M4/P4

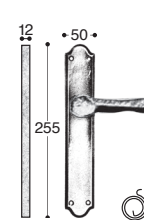

M4/P6

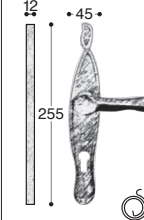

Maniglie con placca
 Handles with plaques
 Griffe mit Platten
 Poignées avec plaques

M4/DK



DK - Maniglie per finestra
 Window handles
 Fenstergriffe
 Poignée de fenetre



NB AZ VI WB AS AI OPW BLK RUB RUW

⇒ pag. 144



collezione **Ottagonale**

La collezione si richiama al primo Novecento, con un tratto vagamente Art Decò, caratterizzata dalla sua sezione ottagonale che ne decide lo stile.

The collection recalls the early twentieth century, with a vague Art Deco trait, characterized by its octagonal section that marks its style.

Die Kollektion mit einem vagen Art-Deco-Flair erinnert an das frühe 20. Jahrhundert und zeichnet sich durch das Achteck aus, das den Stil bestimmt.

La collection se réfère au début du vingtième siècle, avec un trait vaguement Art Déco, caractérisée par sa section octogonale propre à ce style.



collezione Ottagonale

Giara Art design

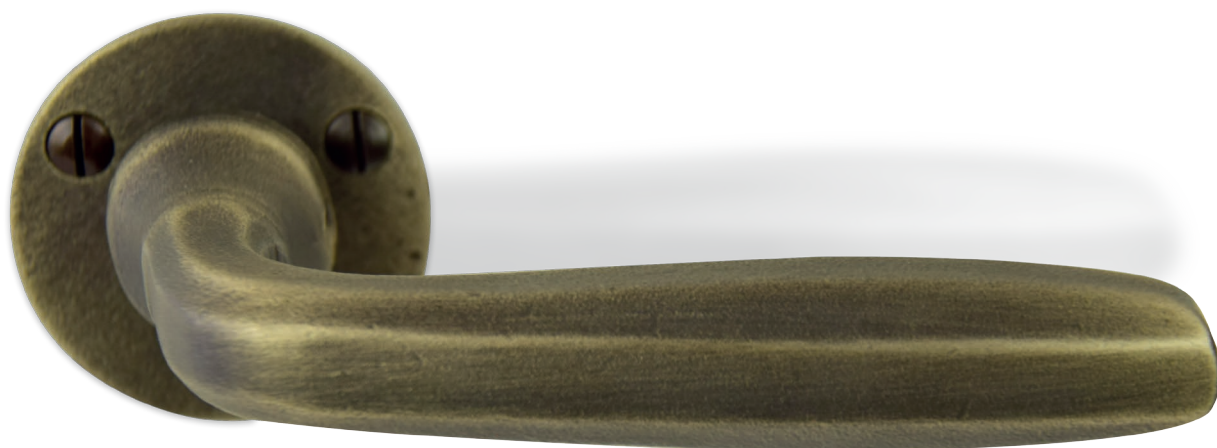

M11/R3 - finish AI

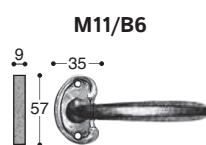
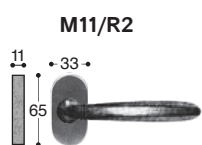
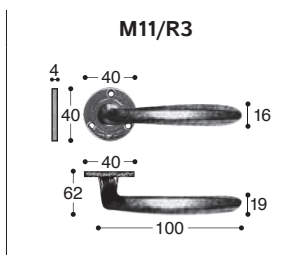

Maniglie con rosetta
Handles with rosettes
Griffe mit Rosetten
Poignées avec rosettes

M11/DK

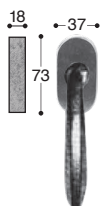

DK - Maniglie per finestra
Window handles
Fenstergriffe
Poignée de fenetre



NB

AZ

VI

WB

AS

AI

OPW

BLK

RUB

RUW

⇒ pag. 144



collezione Ovale

L'ovale è la forma incastonata all'interno della maniglia, una forma classica e perfetta che sembra racchiudere ricordi di un tempo passato.

The oval is the shape set inside the handle, a classic and perfect shape that seems to enclose memories of a time past.

Das Oval ist die Form, die in den Griff eingefasst ist, eine klassische und perfekte Form, die an eine vergangene Zeit zu erinnern scheint.

L'ovale est la forme sertie à l'intérieur de la poignée de porte, une forme classique et parfaite qui semble renfermer des souvenirs d'autrefois.



collezione **Ovale**

Giara Art design



M2/R1 - finish **BLK**

M2/R1

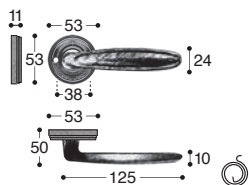

Maniglie con rosetta
Handles with rosettes
Griffe mit Rosetten
Poignées avec rosettes

M2/P1

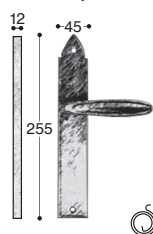

M2/P2

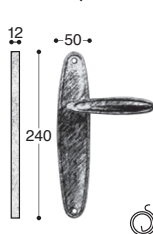

M2/P3

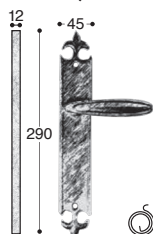

M2/P4

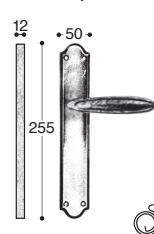

M2/P6

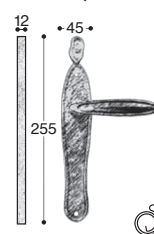

Maniglie con placca
Handles with plaques
Griffe mit Platten
Poignées avec plaques

M2/DK

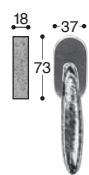

Po10-R1

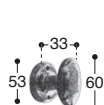

PoTL-50/R1



PoTL-80/R68



PoTL-110/R68



DK - Maniglie per finestra
Window handles
Fenstergriffe
Poignée de fenetre

Pomoli / Knobs / Knöpf / Boutons



NB

AZ

VI

WB

AS

AI

OPW

BLK

RUB

RUW

⇒ pag. 144



L'ovale diventa quel dettaglio che rende la casa più calda grazie al suo colore e a quel suo spirito romantico.

The oval becomes that detail that makes the house warmer thanks to its color and its romantic spirit.

Das Oval wird zu dem Detail, das das Haus dank seiner Farbe und seines romantischen Geistes wärmer wirken lässt.

L'ovale est ce détail qui rend la maison accueillante grâce à sa couleur et à son esprit romantique.





accessori **Ovale**

L'ovale come cameo si adatta perfettamente a firma di arredi dallo stile inconfondibile.

The oval as a cameo fits perfectly with furnishings with an unmistakable style.

Das Oval als Kamee passt perfekt zu Möbelstücken mit unverwechselbarem Stil.

L'ovale en tant que camée s'adapte parfaitement aux ameublements de style.

MA2-128



MA2-254



MA2-457



Maniglie per mobili
Furniture handles
Möbelgriffe
Poignée pour meubles

Po9



Po2/48



Pomolini
Knobs
Knöpfe
Boutons



NB AZ VI WB AS AI OPW BLK BRI RUB RUW

⇒ pag. 144



collezione **Perla**

Perla, con le sue raffinate curve, è perfetta per ambienti ricchi di tessuti e decori tipici dei grandi arredi.

The Perla collection, with its refined curves, is perfect for environments rich in fabrics and decorations typical of large furnishings.

Perla mit ihren raffinierten Rundungen eignet sich perfekt für Umgebungen voller Stoffe und Dekorationen, die typisch für große Ausstattungen sind.

Perle, avec ses courbes raffinées, est parfaite pour les environnements riches en tissus et en ornements typiques des grands ameublements.



collezione Perla

Giara Art design



M14G/R1 - finish AZ

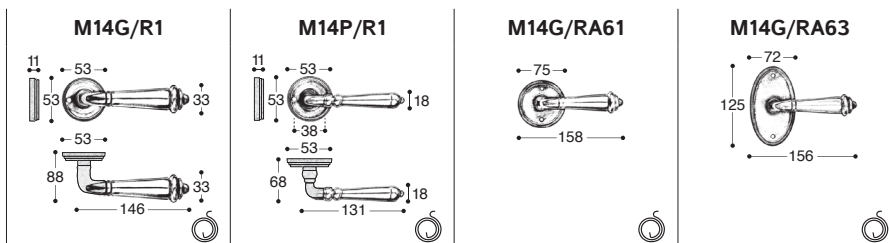

Maniglie con rosetta
 Handles with rosettes
 Griffe mit Rosetten
 Poignées avec rosettes

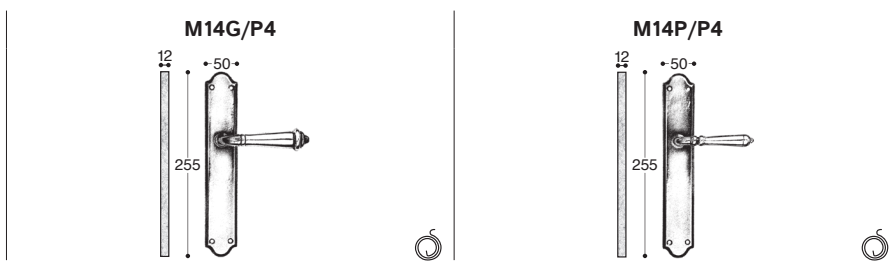

Maniglie con placca
 Handles with plaques
 Griffe mit Platten
 Poignées avec plaques

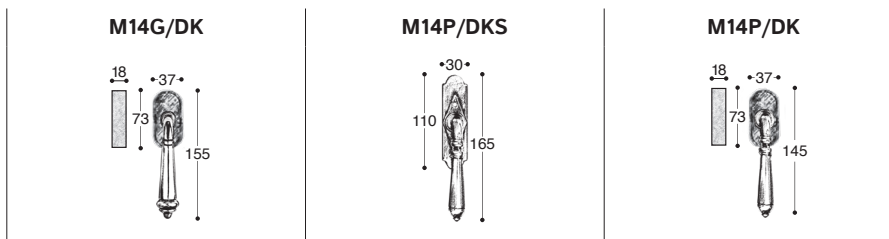

DK - Maniglie per finestra
 Window handles
 Fenstergriffe
 Poignée de fenetre



NB AZ VI WB AS AI OPW BLK RUB RUW → pag. 144



collezione Torciglia

Il metallo si torce e diventa maniglia,
nel più tradizionale stile delle maniglie
battute a mano.

The metal is twisted, and it becomes a handle,
in the most traditional style of hand-beaten
handles.

Metall wird gedreht und wird - mit der
traditionellen Methode der handgeschmiedeten
Griffe - zu einem Griff.

Le métal se tord et devient une poignée de
porte, dans le style le plus traditionnel des
poignées battues à la main.



collezione Torciglia

Giara Art design



M5/R1 - finish AI

M5/R1

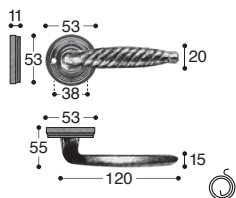

Maniglie con rosetta
Handles with rosettes
Griffe mit Rosetten
Poignées avec rosettes

M5/P1

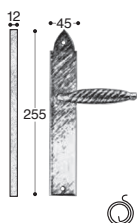

M5/P2

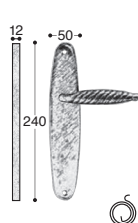

M5/P3

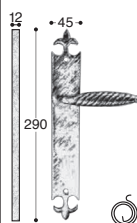

M5/P3-35

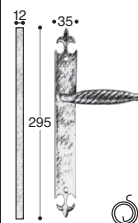

M5/P4

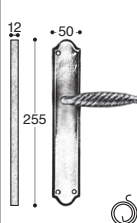

M5/P6

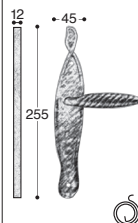

Maniglie con placca
Handles with plaques
Griffe mit Platten
Poignées avec plaques

M5/DK



Po5T-50/R1



Po5/R1



DK - Maniglie per finestra
Window handles
Fenstergriffe
Poignée de fenetre

Pomoli / Knobs / Knöpf / Boutons



NB AZ VI WB AS AI OPW BLK RUB RUW ⇨ pag. 144



Ambienti rustici, pieni di quel sapore intriso di materiali naturali legati a un nostalgico passato.

Rustic environments, full of that flavor imbued with natural materials linked to a nostalgic past.

Rustikale Umgebungen als Ausdruck des Geschmacks, der von natürlichen Materialien geprägt wird, die mit einer nostalgischen Vergangenheit verbunden sind.

Des pièces rustiques, remplies de cette saveur empreinte de matériaux naturels liés à un passé nostalgique.

accessori Torciglia

Le torsioni evidenziate dalle linee che percorrono le forme fanno di questi accessori un complemento tra i più suggestivi per impatto visivo.

The twists highlighted by the lines that run through the shapes make these accessories one of the most suggestive complements for visual impact.

Die Drehungen, die von den Linien, die durch die Formen verlaufen, hervorgehoben werden, verleihen diesem Zubehör eine besondere visuelle Wirkung.

Les torsions accentuées par les lignes qui parcourent les formes font de ces accessoires un complément parmi les plus suggestifs d'un point de vue visuel.

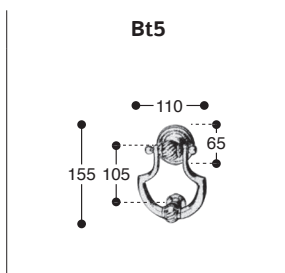
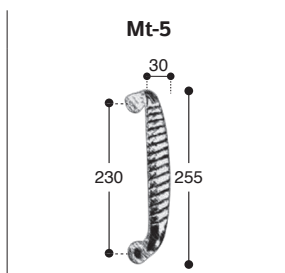

Maniglione
Pull handle
Türgriff
Tirant

Battente
Doorknocker
Türklopfer
Heurtoir

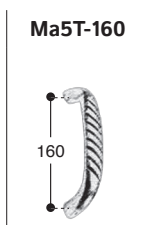
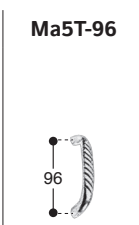
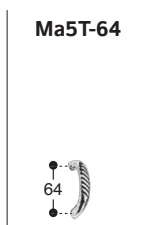

Maniglie per mobili
Furniture handles
Möbelgriffe
Poignée pour meubles

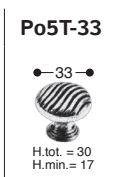
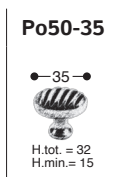
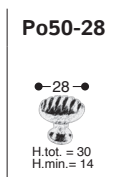

Pomolini / Knobs
Knöpfe / Boutons

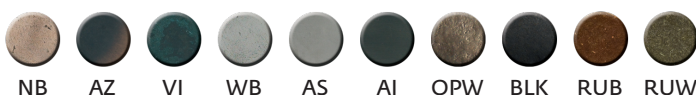

⇒ pag. 144

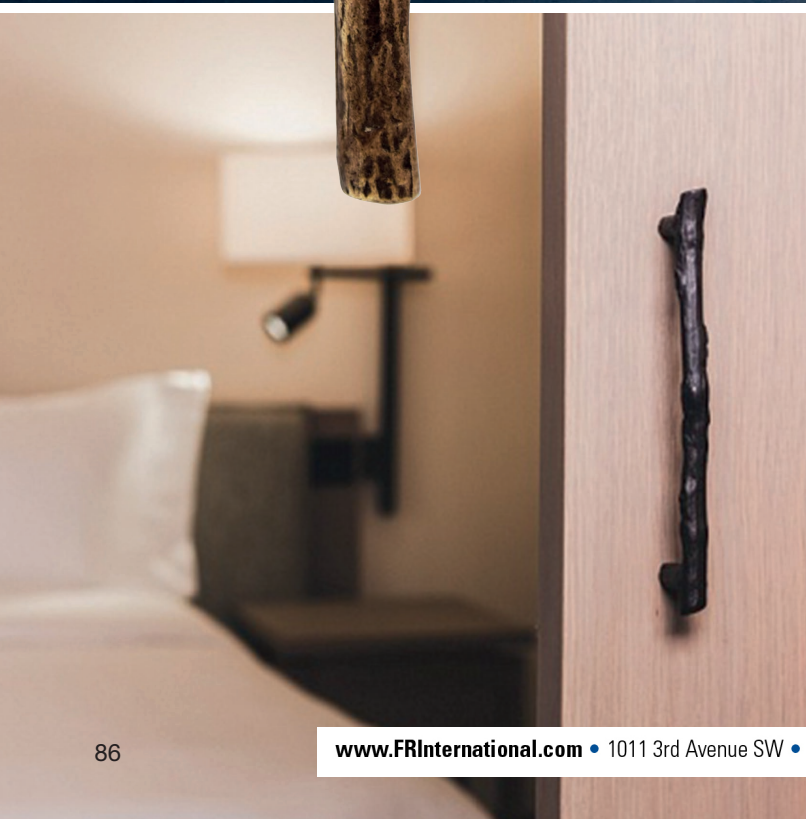

collezione **Tronco**

Autentica scultura, che con la sua foggia rispecchia la bellezza della natura, implementata dall'essenza del bronzo.

Authentic sculpture, its shape reflects the beauty of nature, implemented from the essence of bronze.

Eine authentische Skulptur, die mit ihrer Form die Schönheit - dank der Beschaffenheit von Bronze - der Natur widerspiegelt.

La sculpture authentique réalisée grâce à la particularité du bronze, reflète la beauté de la nature.



collezione **Tronco**

Giara Art design



M85/R1 - finish NB

M85/R1

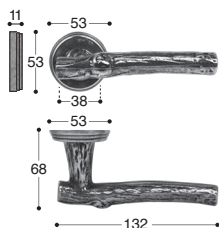

Maniglie con rosetta
Handles with rosettes
Griffe mit Rosetten
Poignées avec rosettes

M85/DK

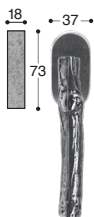

DK - Maniglie per finestra
Window handles
Fenstergriffe
Poignée de fenetre



NB

AZ

VI

WB

AS

AI

OPW

BLK

RUB

RUW

⇒ pag. 144



La natura è pienamente rappresentata nelle creazioni della collezione Tronco come se si fosse all'improvviso materializzata.

Nature is fully represented in the creations of the Tronco collection as if it had suddenly materialized.

Die Natur ist in den Kreationen der Tronco-Kollektion vollständig vertreten, als ob sie sich plötzlich materialisiert hätte.

La nature est entièrement représentée dans les créations de la collection Tronco comme si cette dernière s'était soudainement matérialisée.



accessori Tronco

Gli accessori della linea Tronco esaltano lo spirito di questa collezione donando il senso della natura in tutta la sua bellezza.

The accessories of the Tronco line enhance the spirit of this collection giving the sense of nature in all its beauty.

Das Zubehör der Produktlinie Tronco unterstreicht den Geist dieser Kollektion, indem es den Sinn für die Natur in ihrer ganzen Schönheit vermittelt.

Les accessoires de la ligne Tronco exaltent l'esprit de cette collection en offrant le sens de la nature dans toute sa beauté.

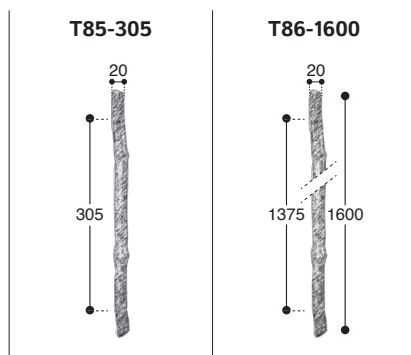

Maniglioni
Pull handles
Türgriff
Tirants

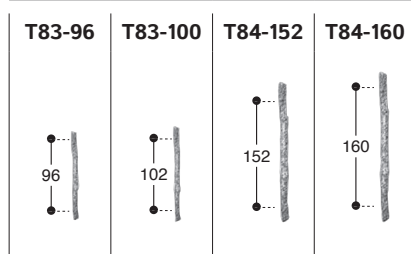

Maniglie per mobili
Furniture handles
Möbelgriffe
Poignée pour meubles

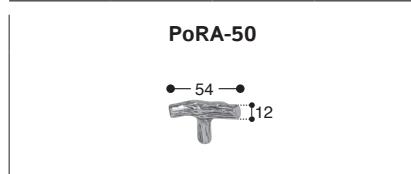

Pomoli
Knobs
Knöpfe
Boutons



NB AZ VI WB AS AI OPW BLK RUB RUW

⇒ pag. 144



collezione **Virgola**

Sintesi di un disegno classico che sposa con leggerezza ed eleganza gli ambienti più disparati.

Synthesis of a classic design that combines with the most diverse environments with lightness and elegance.

Die Synthese eines klassischen Designs, das mit Leichtigkeit und Eleganz in die unterschiedlichsten Umgebungen passt.

Synthèse d'un design classique qui épouse avec légèreté et élégance les environnements les plus variés.



collezione **Virgola**
Giara Art design



M9/R3 - finish WB

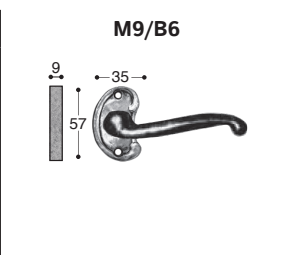
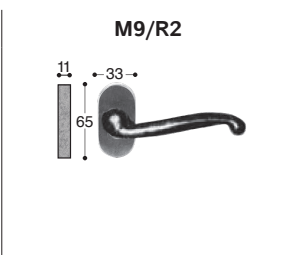
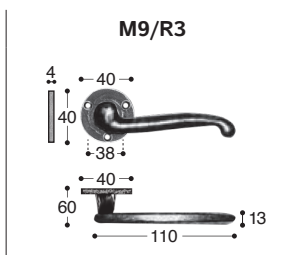

Maniglie con rosetta
Handles with rosettes
Griffe mit Rosetten
Poignées avec rosettes

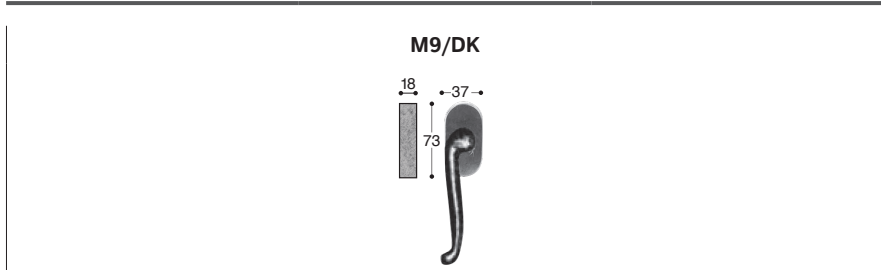

DK - Maniglie per finestra
Window handles
Fenstergriffe
Poignée de fenetre



⇒ pag. 144



collezione **Wave**

L'impugnatura è ispirata ad una forma tradizionale usata per portoni di epoche passate.

The handle is inspired by a traditional shape used for doors of past eras.

Inspiriert von einer traditionellen Form für Tore der Vergangenheit.

La poignée est inspirée d'une forme traditionnelle utilisée pour les portes d'autres époques.



collezione Wave

Giara Art design



ALP51/R1 - finish NB

ALP51/R1



Maniglie con rosetta
Handles with rosettes
Griffe mit Rosetten
Poignées avec rosettes

ALP51-P4

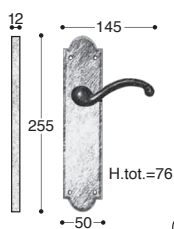

ALP51-P3

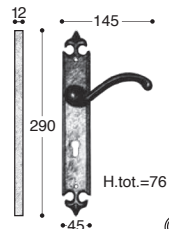

Maniglie con placca
Handles with plaques
Griffe mit Platten
Poignées avec plaques

ALP51/DK



DK - Maniglie per finestra
Window handles
Fenstergriffe
Poignée de fenetre



NB

AZ

VI

WB

AS

AI

OPW

BLK

RUB

RUW

⇒ pag. 144



Wave Alpine

Giara Art design



ALP51/RA61

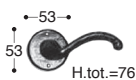

ALP51/RA62

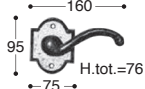

ALP51/RA63

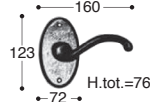

Maniglie con rosetta
Handles with rosettes
Griffe mit Rosetten
Poignées avec rosettes

ALP51-3007

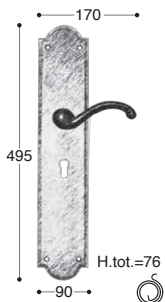

ALP51-3008

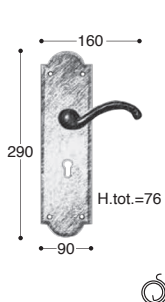

ALP51-P4

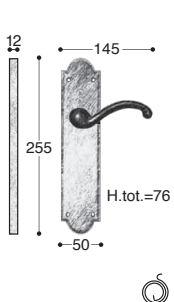

ALP51-3210

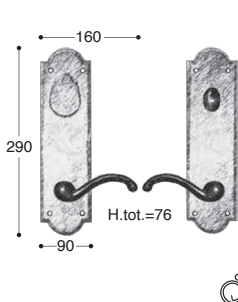

ALP51-P3

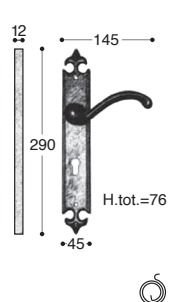

Maniglie con placca
Handles with plaques
Griffe mit Platten
Poignées avec plaques

BA-C



BA-Y



ALP50-RA61



ALP50-RA62



ALP50-RA63

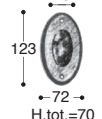

Bocchette
Escutcheon
Rosace de cle
Schlüsseln rosetten



NB AZ VI WB AS AI OPW BLK RUB RUW

⇒ pag. 144



Alpine

Giara Art design



ALP3010-ML09-50

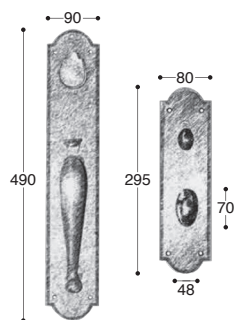

ALP4010-ML09-50

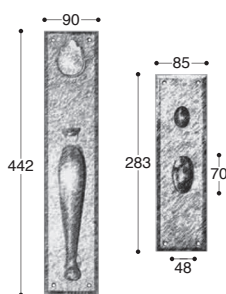

Set ingresso
Entry set US Mortise L.
Entry Set
Entry set

ALP3008-ML09

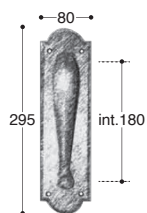

ALP4008-ML09

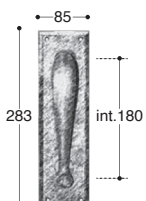

Maniglioni
Single pulls
Türgriff
Tirants



NB

AZ

VI

WB

AS

AI

OPW

BLK

RUB

RUW

⇒ pag. 144

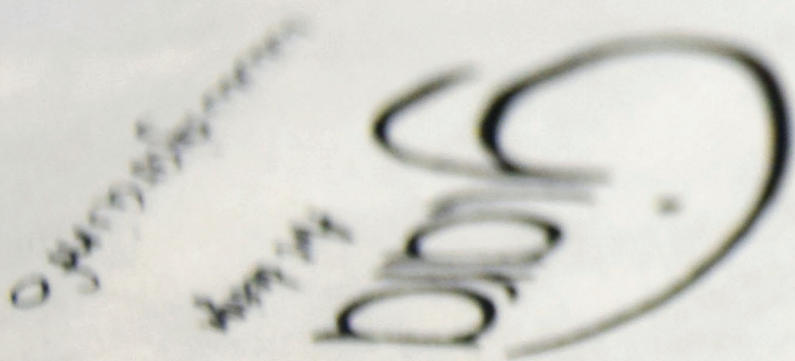

Collezione ottone

Collezione realizzata in ottone nel più fedele rispetto delle lavorazioni di Giara Art design che significa prodotti realizzati con tecniche millenarie, come la fusione in terra e la ceratura a mano, che conferiscono ad ogni singolo pezzo unicità e genuinità.

Brass Collection

Collection made of brass in the most faithful respect of Giara Art design workmanship, like sand casting and hand waxing, that grants every single piece uniqueness and wholesomeness.

Messingsammlung

Die die Herstellung von Giara Art design, Erdguss und Hand wachs respectiert, die den Stücken Einzigartigkeit und Echtheit verleihen.

Collection en laiton

Réalisée dans le respect le plus fidèle de la fabrication de Giara Art design, telles que laiton coulé dans du sable et ciré à la main, qui confèrent à chaque pièce unicité et authenticité.



collezione ottone



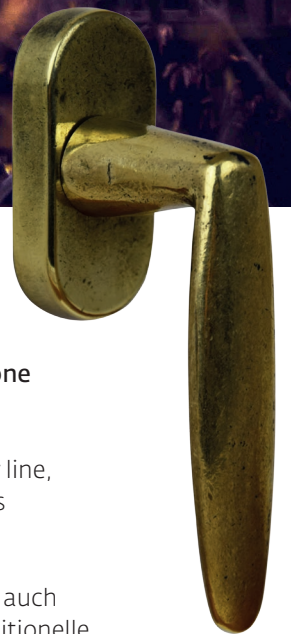

collezione Ala

Linea semplice, classica e pure contemporanea, senza tempo. L'ottone tradizionale ne esalta l'essenzialità.

Simple, classic and pure contemporary line, timeless. Traditional brass enhances its essentiality.

Einfache Linie, die sowohl klassisch als auch zeitgenössisch und zeitlos ist. Das traditionelle Messing unterstreicht ihre Essentialität.

Ligne simple, classique et également contemporaine, intemporelle. Le laiton traditionnel en exalte son aspect essentiel.





collezione Ala

Giara Art design

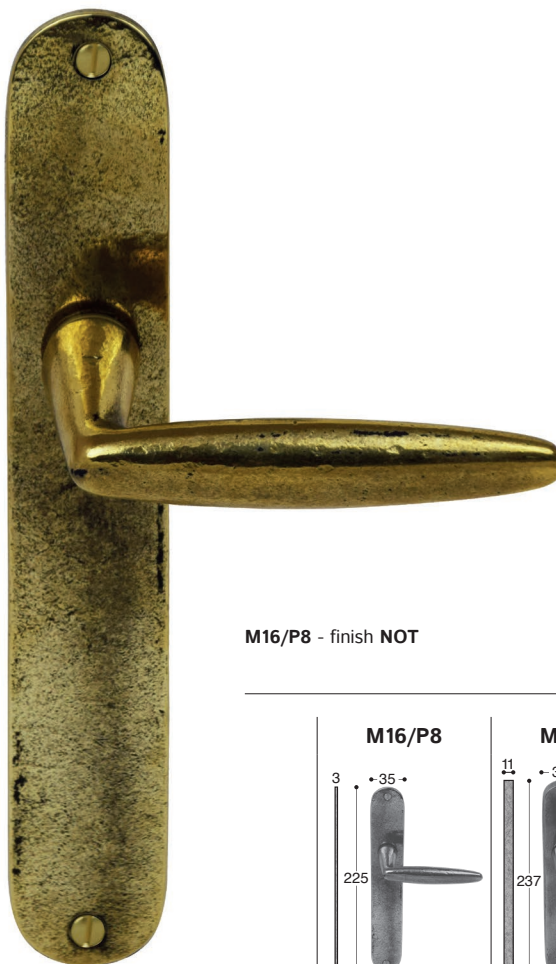

M16/P8 - finish NOT

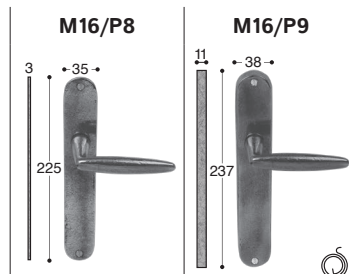

Maniglie con placca
 Handles with plaques
 Griffe mit Platten
 Poignées avec plaques

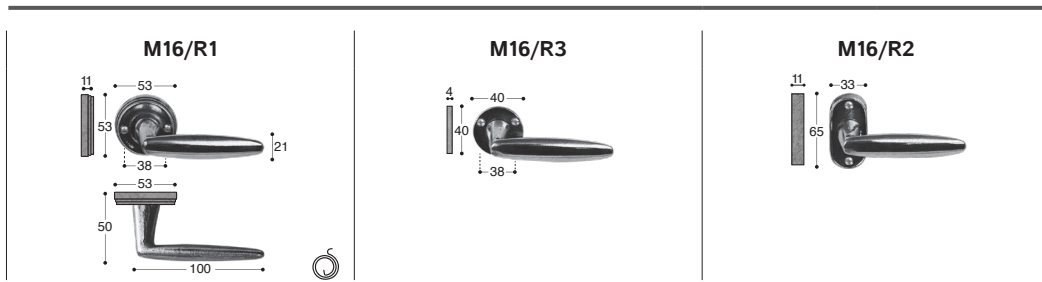

Maniglie con rosetta
 Handles with rosettes
 Griffe mit Rosetten
 Poignées avec rosettes

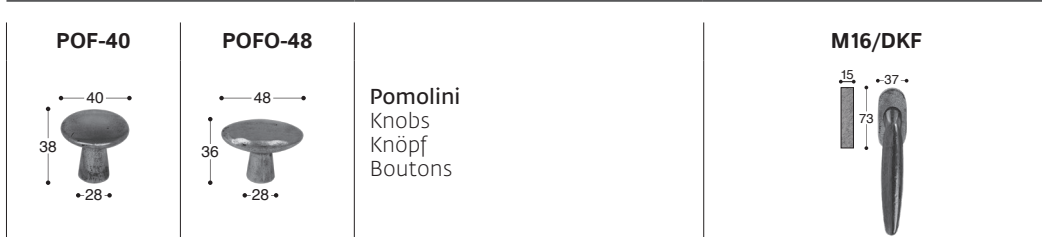

Pomolini
 Knobs
 Knöpfe
 Boutons

DK - Maniglie per finestra
 Window handles
 Fenstergriffe
 Poignée de fenetre



NOT NOL

⇒ pag. 144



collezione **Cono**

Una barra di ottone piegata che termina leggermente conica per facilitarne la prensilità.

A bent brass bar that ends in a slightly conical shape to facilitate its prehensibility.

Ein gebogener Messingstab, der leicht konisch endet, um die Greiffähigkeit zu erleichtern.

Une barre en laiton pliée qui se termine de manière légèrement conique pour en faciliter sa prise.



collezione Cono

Giara Art design



M18/R1 - finish NOT

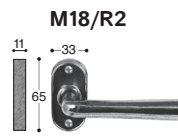
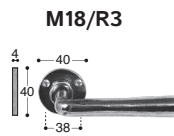
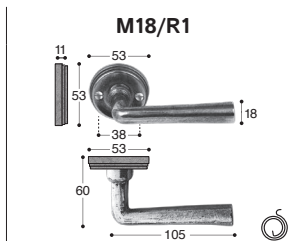

Maniglie con rosetta
Handles with rosettes
Griffe mit Rosetten
Poignées avec rosettes

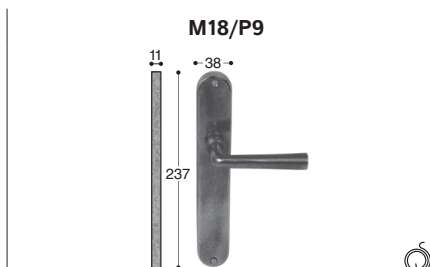
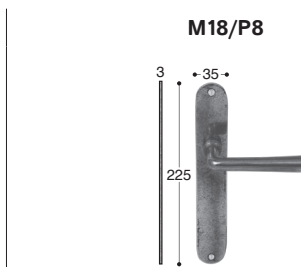

Maniglie con placca
Handles with plaques
Griffe mit Platten
Poignées avec plaques

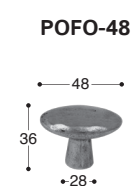

DK - Maniglie per finestra
Window handles
Fenstergriffe
Poignée de fenetre

Pomolini / Knobs / Knöpfe / Boutons



NOT NOL ⇨ pag. 144



collezione Mila

Come le vecchie maniglie ottenute da un quadrello di metallo piegato. Forma essenziale ed ergonomica.

Like the old handles obtained from a folded metal square. Essential and ergonomic shape.

Wie die alten Griffe, die man aus einem gebogenen Metall erhält. Essentielle und ergonomische Form.

Comme les vieilles poignées obtenues par un carreau en métal plié. Forme essentielle et ergonomique.





collezione **Mila**
Giara Art design



M17/R4 - finish NOT

<p>M17/R1</p>	<p>M17/R3</p>	<p>M17/R4</p>	<p>M17/R5</p>	<p>M17/R12R</p>	<p>Maniglie con rosetta Handles with rosettes Griffe mit Rosetten Poignées avec rosettes</p>
<p>M17/P5</p>		<p>M17/P7</p>			<p>Maniglie con placca Handles with plaques Griffe mit Platten Poignées avec plaques</p>
<p>M17/DKF</p>		<p>M17/DKR</p>			<p>DK - Maniglie per finestra Window handles Fenstergriffe Poignée de fenetre</p>



NOT NOL ⇨ pag. 144



collezione Tosca

Il nome riprende la foggia di questa collezione, perfetta per inserirsi in una delle più conosciute architetture rustiche del mondo.

The name takes up the shape of this collection, perfect to fit into one of the most famous rustic architectures in the world.

Der Name bezieht sich auf die Form dieser Kollektion, die perfekt in eine der bekanntesten rustikalen architektonischen Umfeld der Welt passt.

Le nom de cette collection s'insère parfaitement dans une des architectures rustiques les plus connues au monde.



collezione Tosca

Giara Art design



M15/R3 - finish NOL

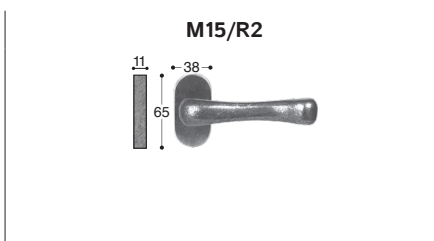
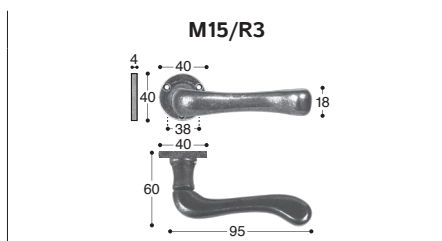

Maniglie con rosetta
Handles with rosettes
Griffe mit Rosetten
Poignées avec rosettes

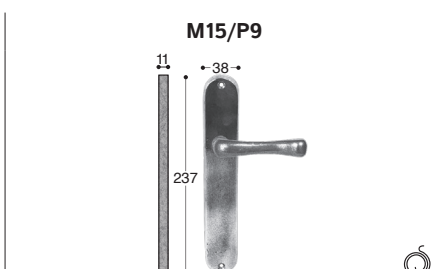
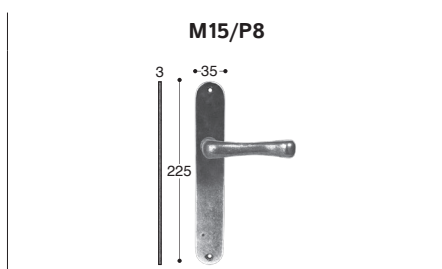

Maniglie con placca
Handles with plaques
Griffe mit Platten
Poignées avec plaques

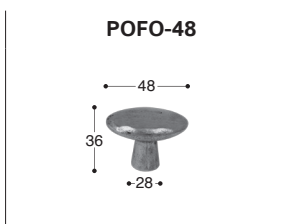
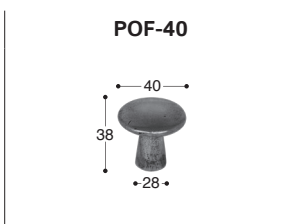
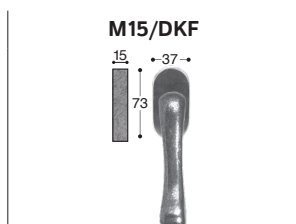

DK - Maniglie per finestra
Window handles
Fenstergriffe
Poignée de fenetre

Pomolini / Knobs / Knöpf / Boutons



NOT NOL

⇒ pag. 144



Rosette	108
Placche	109
Bocchette	110
Accessori	111-112-115
Alzanti scorrevoli	113
Finger plate	114
Candelabri	116-117



Accessori

Gli accessori sono l'ideale complemento per conferire massimo valore a spazi e arredi. Nei dettagli infatti si cela quella perfezione che rende speciale l'intervento progettuale, attribuendo forza al risultato finale.

Accessories

Accessories are the ideal complement to give maximum value to spaces and furnishings. In fact, there is perfection in these details that makes the design project special, adding strength to the final result.

Zubehör

Das Zubehör ist die ideale Ergänzung, um Räumen und Einrichtungsgegenständen einen maximalen Wert zu verleihen. In den Details verbirgt sich nämlich jene Perfektion, die dem Projekt das Besondere und dem Endergebnis Wirkung verleiht.

Accessoires

Les accessoires constituent un complément parfait pour apporter le plus de valeur possible aux espaces et aux meubles. On peut voir dans les détails de cette perfection unique, la force du résultat final.



Rosette

Giara Art design

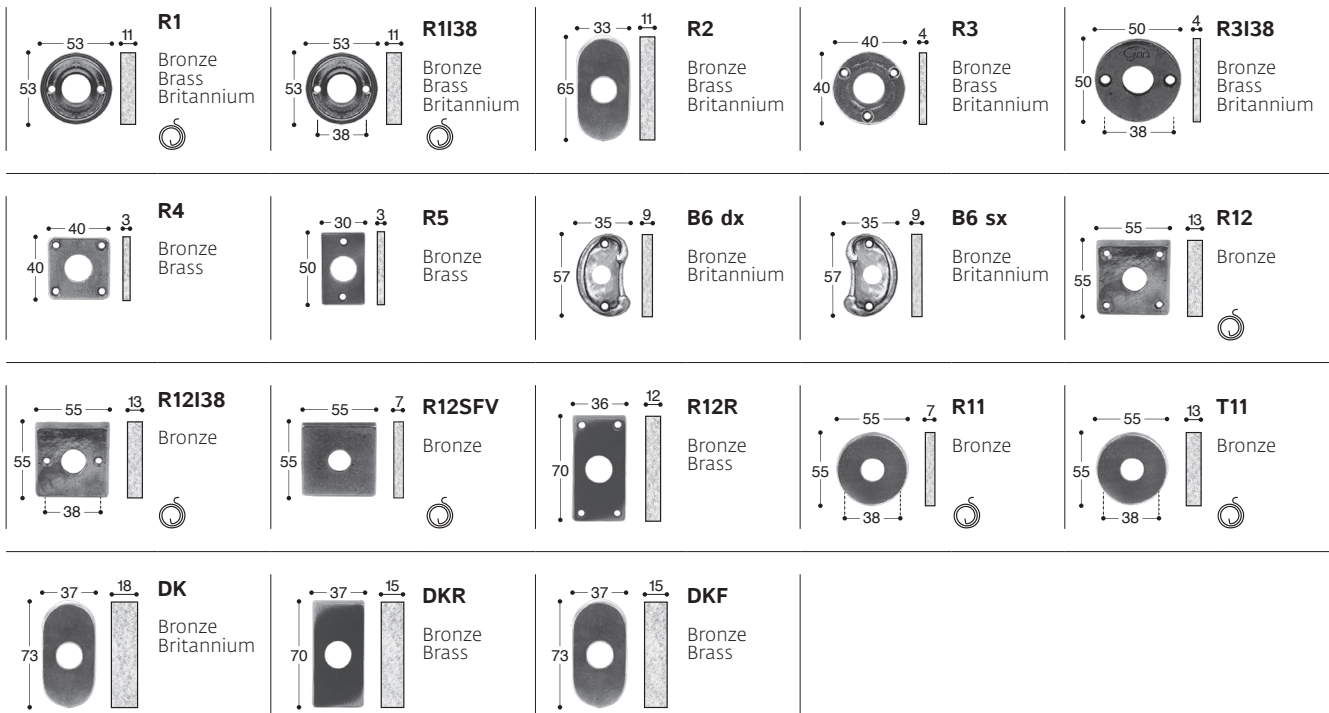
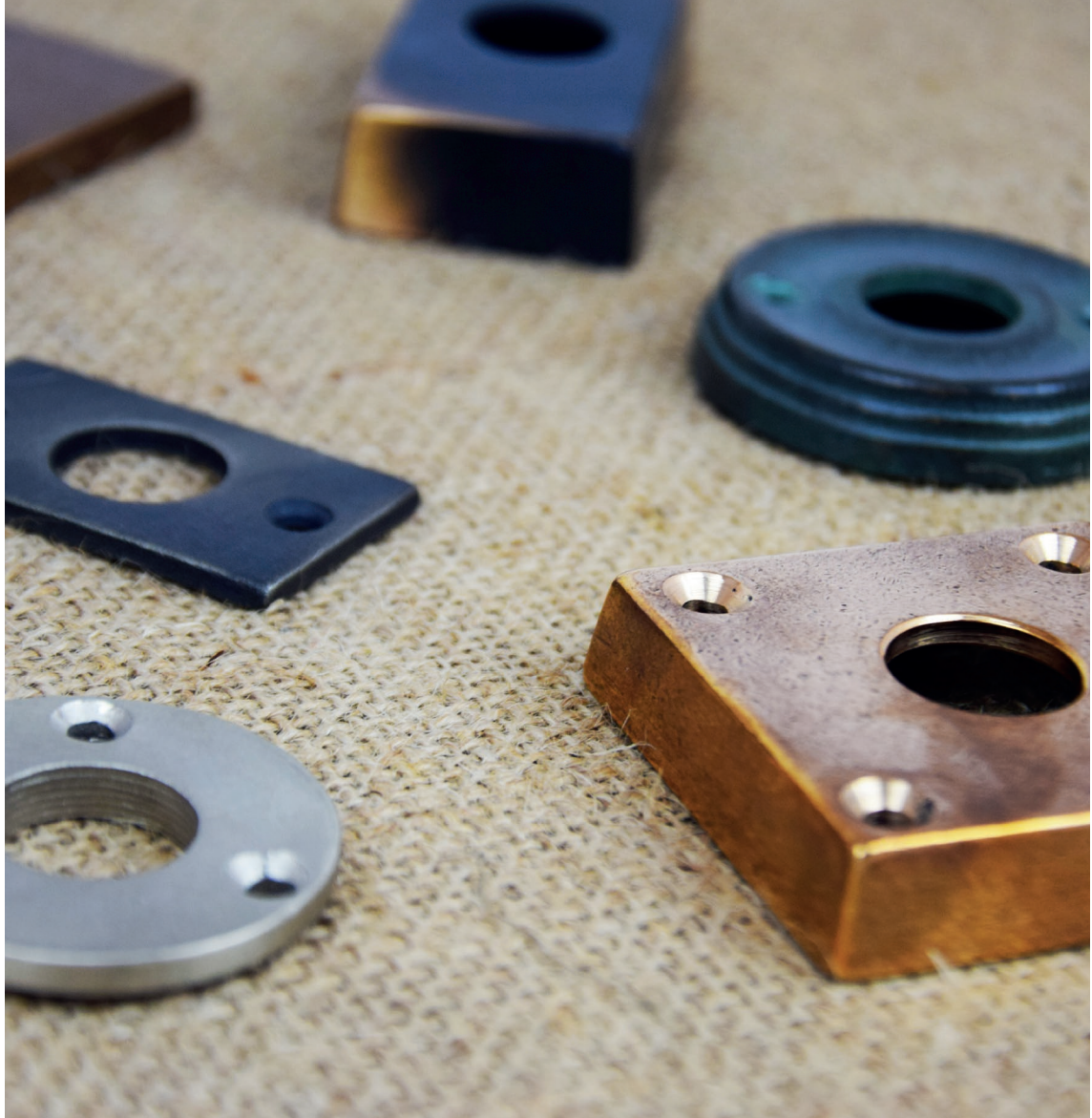

Con molla - Springloaded - Mit Feder - Avec ressort



NB AZ VI WB AS AI OPW BLK BRI RUB RUW NOT NOL ⇨ pag. 144



Placche

Giara Art design

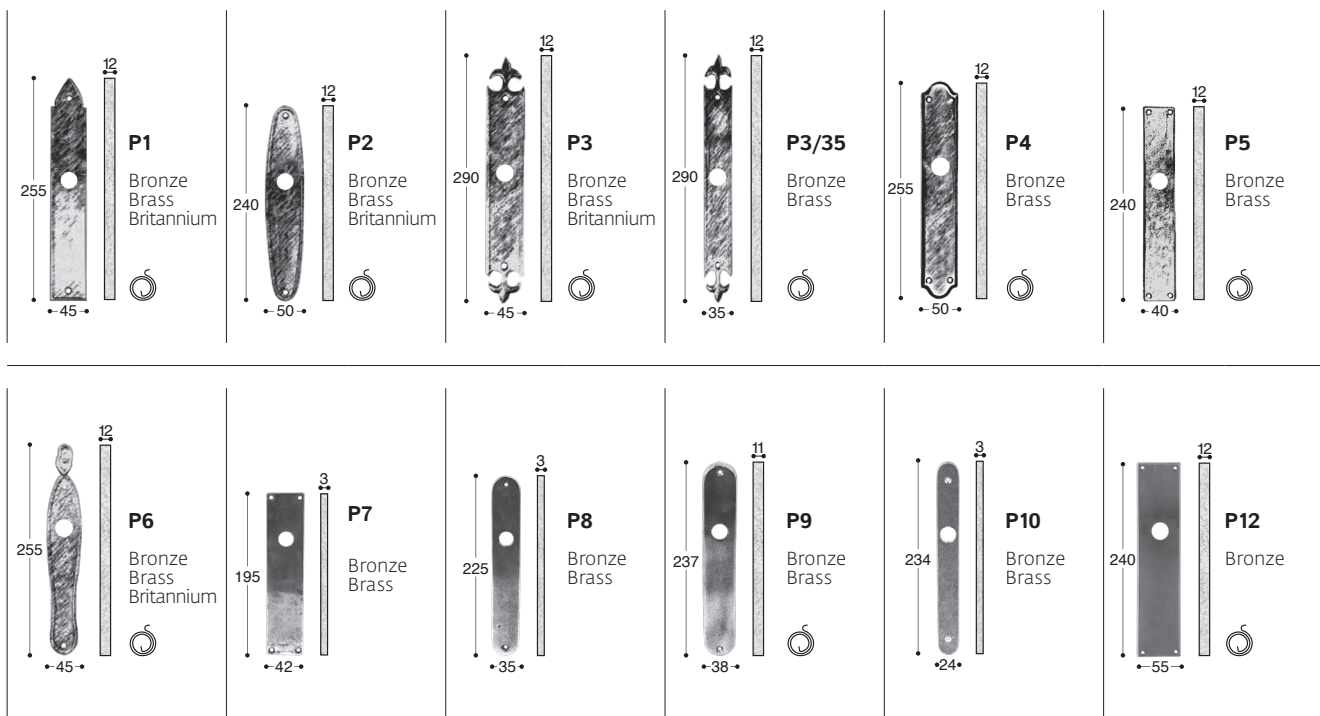

Con molla - Springloaded - Mit Feder - Avec ressort



NB

AZ

VI

WB

AS

AI

OPW

BLK

BRI

RUB

RUW

NOT

NOL

⇒ pag. 144



Bocchette

Giara Art design



<p>B1 Patent B1 Yale Bronze Brass Britannium</p>	<p>B1138 Patent B1138 Yale Bronze Brass Britannium</p>	<p>B2 Patent B2 Yale Bronze Brass Britannium</p>	<p>B3 Patent B3 Yale Bronze Brass Britannium</p>	<p>B3138 Patent B3138 Yale Bronze Brass Britannium</p>
<p>BA Patent BA Yale</p>	<p>B4 Patent B4 Yale Bronze Brass</p>	<p>B5 Patent B5 Yale Bronze Brass</p>	<p>B6 Patent B6 Yale Bronze Britannium</p>	<p>B11 Patent B11 Yale Bronze</p>
<p>BT11 Patent BT11 Yale Bronze</p>	<p>B12 Patent B12 Yale Bronze</p>	<p>B12138 Patent B12138 Yale Bronze</p>	<p>B12SFV Patent B12SFV Yale Bronze</p>	<p>B12R Patent B12R Yale Bronze Brass</p>
<p>B1 DM Bronze Brass</p>	<p>B12 DM Bronze</p>			



⇒ pag. 144



Accessori

Giara Art design

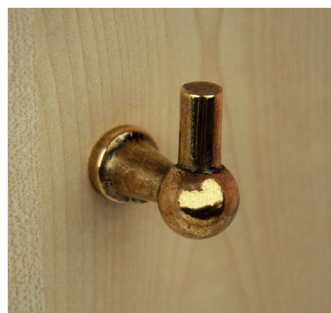
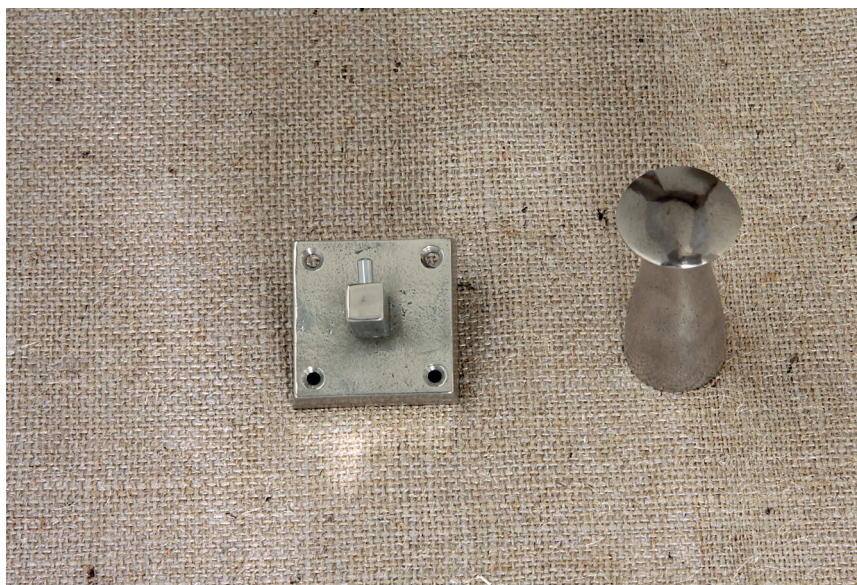

Fermaporte / Door stopper Türpuffer / Butoir de porte



FPT-18
Bronze



FPQ-25
Bronze



FPT-33
Bronze



PoTL-30DS
Bronze



PoTL-30DS
Britannium



FPQ-40
Bronze

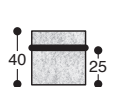

Appendiabiti / Hooks / Kleiderbügel / Crochet porte-habits

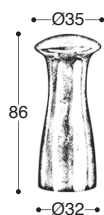

Ap20-88
Bronze

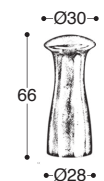

Ap20-66
Bronze

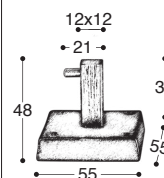

Ap-12
Bronze

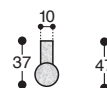

Ap-8
Bronze



NB

AZ

VI

WB

AS

AI

OPW

BLK

BRI

RUB

RUW

⇒ pag. 144



Accessori

Giara Art design



	<p>BC-270 Britannium</p>		<p>ALP60-RA61 Bronze</p>		<p>Bt 5 Britannium</p>
	<p>BC-330 est. Bronze</p>		<p>ALP60-RA62 Bronze</p>		<p>Bt 12 Bronze</p>
	<p>BC-330 int. Bronze</p>		<p>ALP60-RA63 Bronze</p>		



NB AZ VI WB AS AI OPW BLK BRI RUB RUW ⇒ pag. 144



Alzanti scorrevoli

Giara Art design

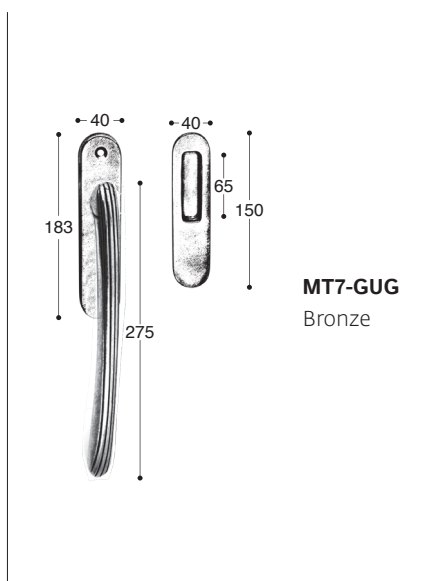
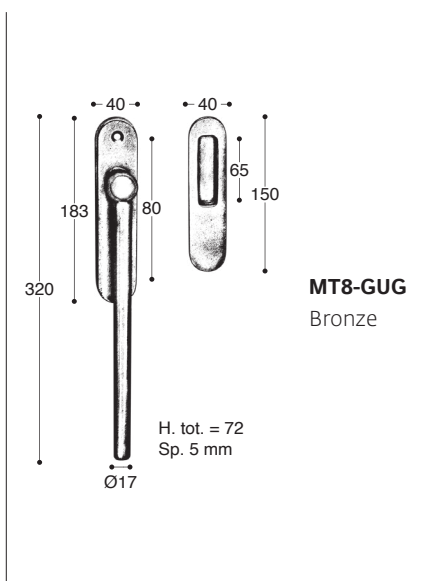
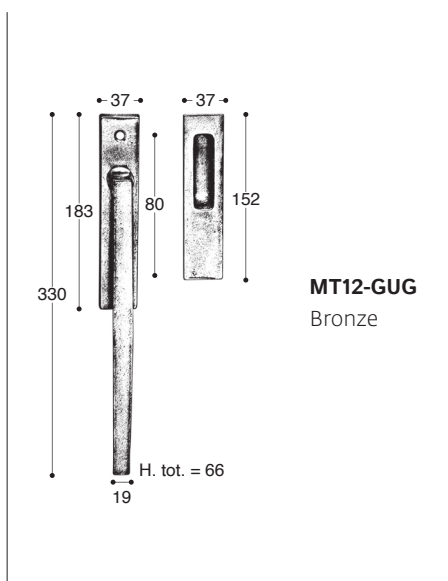

⇒ pag. 144



Finger plate

Giara Art design

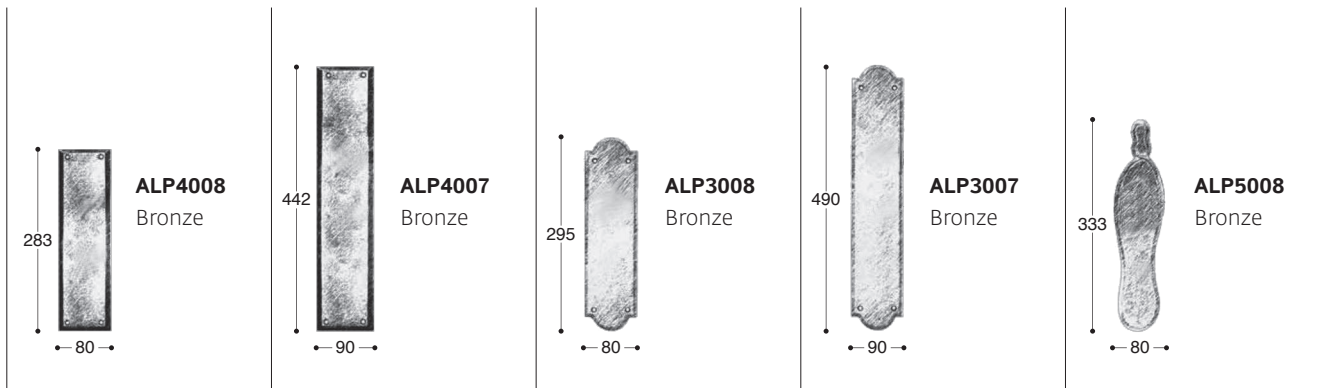

⇒ pag. 144



Accessori

Giara Art design

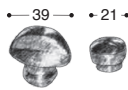
WC01
Britannium
Bronze



WC02
Bronze

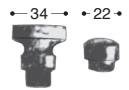

WCo3
Bronze



TK-10

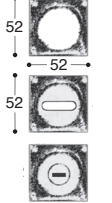

SL12
SL12-KIT
Bronze

H.tot.=11
Ø foro porta = 48

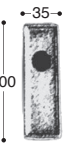

DK-LOCK
Britannium

Bocchette sicurezza acciaio-bronze / Security roses in steel-bronze
Sicherheits-Rosetten Stahl-Bronze / Rosettes de sécurité acier-bronze

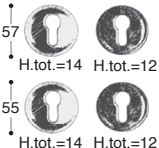

BSY-56
Bronze

H.tot.=14 H.tot.=12



BSY-56
Britannium

H.tot.=14 H.tot.=12



R12BSY
Bronze



BSOY
Bronze



SL02
SL02/FC
Britannium
H.tot.=7
Bronze
H.tot.=4,5

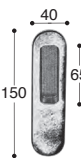

SL-GUG 8
Bronze

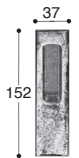

SL-GUG 12
Bronze

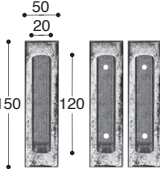

SL10
Bronze

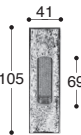

SL12-GUGQ
Bronze



NB

AZ

VI

WB

AS

AI

OPW

BLK

BRI

RUB

RUW

⇒ pag. 144



Candelabri

Giara Art design



Candelabri / Candelabra / Kandelaber / Candélabre

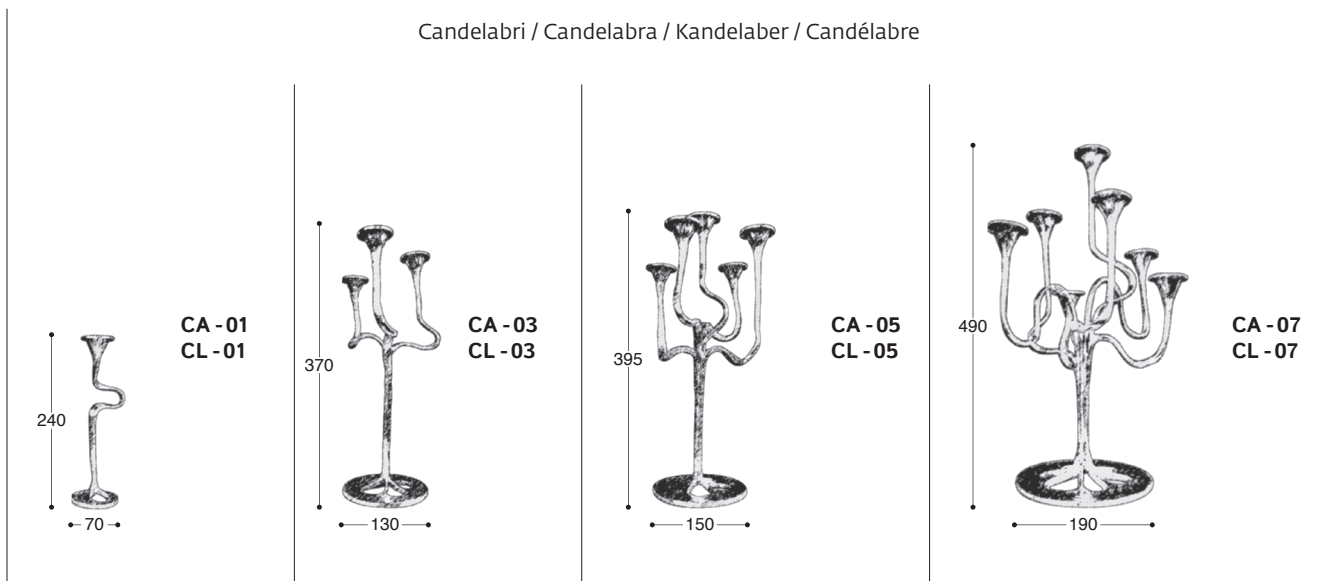

Bagnato in argento Silver plated

Candelabri

Giara Art design



Pigne



Alpino



Quadro

Candelabri / Candelabra / Kandelaber / Candélabre

Alpino
CAH-015

Pigne
CA02-PC

Quadro
CAQ-03

Bagnato in argento Silver plated



Country	120-121
Chemin de Fer	122
Cosmo	123
Croc	124
Dolomite	125
Luna	126
Martellata	127-128
Milano	129
Ovale	130
Pomolini	131-134
Perla	135
Profilo	136
Quadra	137
Torciglia	138
Weave	139
Bocchette - Etnici	140
Piastrelle	141
Leve e cerniere	142



Accessori per mobili

Gli accessori sono l'ideale complemento per conferire massimo valore a spazi e arredi. Nei dettagli infatti si cela quella perfezione che rende speciale l'intervento progettuale, attribuendo forza al risultato finale.

Furniture accessories

Accessories are the ideal complement to give maximum value to spaces and furnishings. In fact, there is perfection in these details that makes the design project special, adding strength to the final result.

Zubehör für Möbel

Das Zubehör ist die ideale Ergänzung, um Räumen und Einrichtungsgegenständen einen maximalen Wert zu verleihen. In den Details verbirgt sich nämlich jene Perfektion, die dem Projekt das Besondere und dem Endergebnis Wirkung verleiht.

Accessoires pour meubles

Les accessoires constituent un complément parfait pour apporter le plus de valeur possible aux espaces et aux meubles. On peut voir dans les détails de cette perfection unique, la force du résultat final.



Country

Il nome evoca lo stile di una collezione di accessori ispirata a un approccio rustico.

The name evokes the style of an accessory collection inspired by a rustic approach.

Der Name beschwört den Stil einer Kollektion von Zubehör herauf, die von einem rustikalen Ansatz inspiriert wurde.

Le nom évoque le style d'une collection d'accessoires inspirée par une approche rustique.

Country

Giara Art design



C74-600

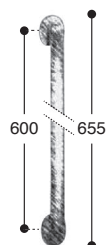

Maniglione
Pull handle
Türgriff
Tirant

C70-64



C70-78



C70-96

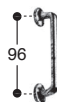

C70-102

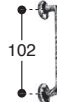

C71-128

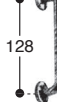

C71-152

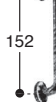

C71-160

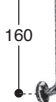

C72-305

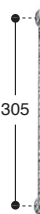

C73-457



Maniglie per mobili
Furniture handles
Möbelgriffe
Poignée pour meubles

C65-90



Bronze

C65-88

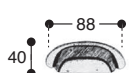

Britannio

C64-48



H.tot.= 34
H.min.=16

C63-45



H.tot.= 37
H.min.= 20

C63-40



H.tot.= 33
H.min.=18

C62-35



H.tot.= 32
H.min.=14

C62-30



H.tot.= 32
H.min.=15

C61-36



H.tot.= 37

C60-30



H.tot.= 27

Pomolini / Knobs
Knöpf / Boutons



NB AZ VI WB AS AI OPW BLK BRI RUB RUW

⇒ pag. 144



Chemin de Fer

Giara Art design



Una collezione particolarmente ricca di accessori per la Chemin de Fer: in ognuna ritroviamo il carattere deciso di questa linea.

The Chemin de Fer accessories collection is particularly rich: in each model, we find the decisive character of this line.

Eine Kollektion mit besonders viel Zubehör ist Chemin de Fer: - überall finden wir den entschlossenen Charakter dieser Kollektion.

Une collection particulièrement riche en accessoires : dans chacune d'entre elles nous retrouvons le caractère particulier de cette ligne.



<p>MT8-224</p>			<p>MT8-300A</p>			<p>MT8-300B</p>			<p>Maniglioni Pull handles Türgriff Tirants</p>
<p>MA8-64</p>	<p>MA8-96</p>	<p>MA8-128</p>	<p>MA8-224</p>	<p>MA8-384</p>	<p>MA8-512</p>	<p>Maniglie per mobili Furniture handles Möbelgriffe Poignée pour meubles</p>			
<p>Po8-45</p>	<p>Po8-55</p>	<p>Po8-25</p>	<p>AP-8</p>	<p>Pomoloni Knobs Knöpfe Boutons</p>					



⇒ pag. 144

Cosmo

Giara Art design



La texture particolare della superficie di Cosmo si adatta perfettamente ai piccoli pomoli, alle maniglie e ai maniglioni, ottenendo l'effetto di un tutto coordinato.

The particular surface texture of the Cosmo accessories adapts perfectly to small knobs, small handles and large handles, thus providing a perfectly coordinated effect.

Die besondere Textur der Oberflächen von Cosmo ist perfekt für kleine und große Griffe geeignet und erzeugt einen koordinierten Effekt.

La texture particulière de la surface de Cosmo s'adapte parfaitement aux petits boutons, aux poignées pour meuble et aux poignées de tirant, en obtenant l'effet d'un ensemble coordonné.



<p>MA90-457</p>	<p>MA90-457W</p>	<p>Maniglione Pull handle Türgriff Tirant</p>	
<p>MA90-128</p>	<p>MA90-160</p>	<p>MA90-305</p>	<p>Maniglie per mobili Furniture handles Möbelgriffe Poignée pour meubles</p>
<p>Po90-33</p>	<p>Po90-33R</p>	<p>Pomolini Knobs Knöpfe Boutons</p>	

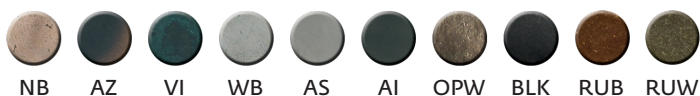

⇒ pag. 144



Croc

Giara Art design

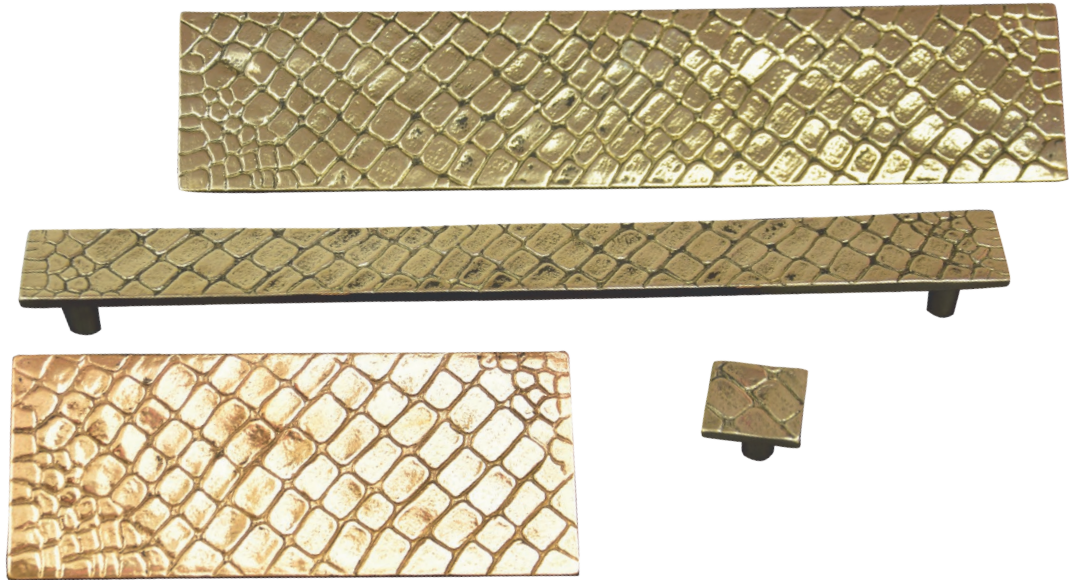

La corazza di uno degli animali più fieri in natura, ispira questa texture forte e selvaggia.

The armor of one of the proudest animals in nature inspires this strong and wild texture.

Der Panzer eines der stolzesten Tiere der Natur inspiriert diese starke und ungezähmte Textur.

La carapace de l'un des animaux les plus fiers en nature, inspire cette texture forte et sauvage.

CROC 160/35 **CROC 320/35** **CROC 160/80** **CROC 320/80**

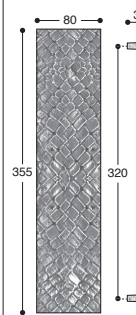
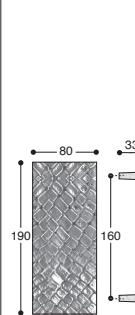
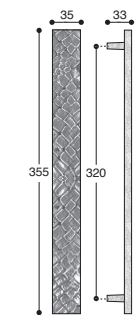
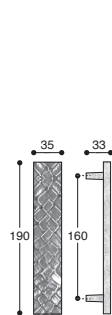

Maniglie per mobili
Furniture handles
Möbelgriffe
Poignée pour meubles

CROC-35

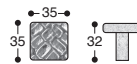

CROC-35R

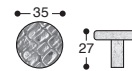

Pomolini
Knobs
Knöpfe
Boutons

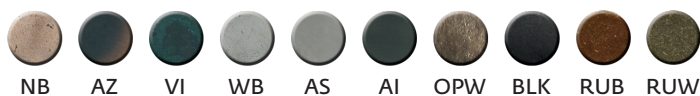

⇒ pag. 144

Dolomite

Giara Art design



Finiture pietra Dolomite

Dolomite stone finishes / Finish Dolomitstein
Finition pierre Dolomite

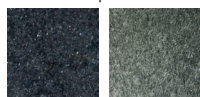

Nero / Black / Swartz / Noir
Verde / Green / Grün / Vert

DS-128	DS-160	DS-305	
			Maniglie per mobili Furniture handles Möbelgriffe Poignée pour meubles
DS-38	DS-38R		
		Pomolini Knobs Knöpfe Boutons	

Un sottile listello di marmo pregiato delle Dolomiti finisce questi accessori, la cornice in bronzo ne esalta l'esclusività.

A thin strip of precious marble from the Dolomite mountains finishes these accessories, the bronze frame enhances its exclusivity.

Ein dünner Streifen aus kostbarem Dolomitmarmor veredelt dieses Zubehör. Der Bronzerahmen unterstreicht die Exklusivität.

Un élément fin de marbre précieux des Dolomites permet d'achever ces accessoires tandis que le cadre en bronze en exalte l'exclusivité.



⇒ pag. 144



Luna

Giara Art design



Da sempre fonte di ispirazione per ogni forma d'arte, qui interpretata da mani di esperti cesellatori del bronzo.

It has always been a source of inspiration for every art form, the Moon is interpreted here by the hands of expert bronze chisellers.

Der Mond war schon immer eine Inspirationsquelle für jede Form der Kunst, die hier von den Händen erfahrener Bronzegießer interpretiert wird.

La lune depuis toujours source d'inspiration de formes artistiques, interprétées ici par des mains d'experts ciseleurs du bronze.

LUN-128

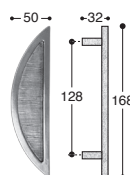

LUN-320



Maniglie per mobili
Furniture handles
Möbelgriffe
Poignée pour meubles

LUN-55



Pomolini
Knobs
Knöpfe
Boutons



⇒ pag. 144

Martellata

Giara Art design



<p>G09-128</p> <p>Bronze/Britannium</p>	<p>G09-160</p> <p>Bronze/Britannium</p>	<p>G09-224</p> <p>Bronze/Britannium</p>	<p>G09-305</p> <p>Bronze/Britannium</p>	<p>G09-320</p> <p>Britannium</p>	<p>Maniglie per mobili Furniture handles Möbelgriffe Poignée pour meubles</p>
<p>G01-30x45</p> <p>Bronze / Britannium</p>	<p>G08-45</p> <p>Bronze / Britannium</p>	<p>G10-40</p> <p>Bronze / Britannium</p>	<p>Pomolini Knobs Knöpfe Boutons</p>		



NB

AZ

VI

WB

AS

AI

OPW

BLK

BRI

RUB

RUW

⇒ pag. 144



Martellata

Giara Art design



G05-96

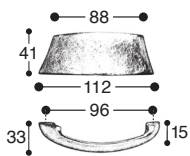

Bronze / Britannium

G07-128

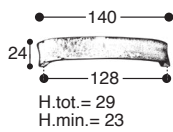

Britannium

G07-160

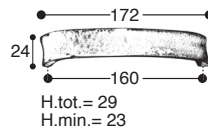

Britannium

Maniglie per mobili
Furniture handles
Möbelgriffe
Poignée pour meubles



NB

AZ

VI

WB

AS

AI

OPW

BLK

BRI

RUB

RUW

⇒ pag. 144

Milano

Giara Art design



Maniglie per mobili o piccoli complementi d'arredo che stupiscono per la loro classicità ma al tempo stesso permeano il contemporaneo.

Handles for furniture or small furnishing accessories that amaze for their classicism but, at the same time, they can permeate the contemporary style.

Griffe für Möbel oder kleine Einrichtungsaccessoires, die immer wieder durch ihre klassische Beschaffenheit beeindrucken und gleichzeitig zeitgenössisch sind.

Des poignées pour meubles ou de petits compléments de décoration qui étonnent par leur aspect classique mais qui en même temps imprègnent le contemporain.



MtMILANO-221

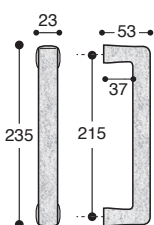

Maniglione
Pull handle
Türgriff
Tirant

MIL-128

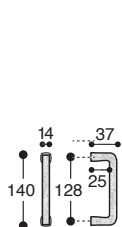

MIL-160

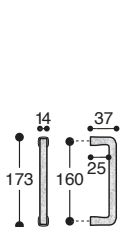

MIL-320

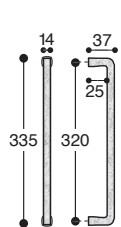

MIL-457W

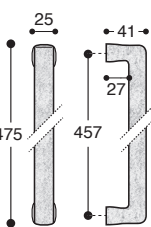

Maniglie per mobili
Furniture handles
Möbelgriffe
Poignée pour meubles

MIL-38

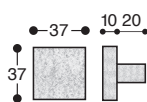

MIL-38R

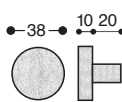

Pomolini
Knobs
Knöpfe
Boutons



NB AZ VI WB AS AI OPW BLK RUB RUW ⇨ pag. 144



Ovale

Giara Art design



L'ovale come cammeo si adatta perfettamente a firma di arredi dallo stile inconfondibile.

The oval as a cameo fits perfectly with furnishings with an unmistakable style.

Das Oval als Kamee passt perfekt zu Möbelstücken mit unverwechselbarem Stil.

L'ovale en tant que camée s'adapte parfaitement aux ameublements de style.

MA2-457



MA2-254

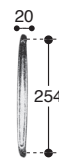

MA2-128



Maniglie per mobili
Furniture handles
Möbelgriffe
Poignée pour meubles

Po9



Po2/48



Pomolini
Knobs
Knöpfe
Boutons



⇒ pag. 144

Pomolini

Giara Art design

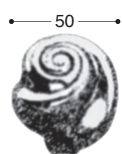

PoRS-50
Britannium



PoRP-26
Britannium

H. tot. = 19
H. min. = 12



PoV-28
Britannium

H. tot. = 25
H. min. = 11

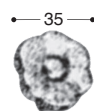

PoMA-35
Britannium

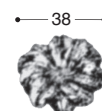

PoDA-38
Britannium



PoRS-28
Britannium

H. tot. = 29
H. min. = 13



PoM-28
Britannium

H. tot. = 36
H. min. = 11



PoD-34
Britannium

H. tot. = 25
H. min. = 13

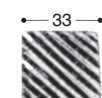

PoQR-33
Britannium

H. tot. = 24
H. min. = 17



PoRS-25
Britannium

H. tot. = 24
H. min. = 11



PoM-23
Britannium

H. tot. = 30
H. min. = 9



PoD-28
Britannium

H. tot. = 23
H. min. = 13

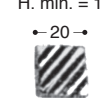

PoQR-24
Britannium

H. tot. = 25
H. min. = 16





Pomolini

Giara Art design

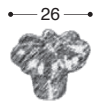

PoFI-26
Britannium
Bronze

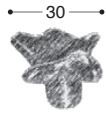

PoAs-33
Britannium
Bronze



H. tot. = 24
H. min. = 13

PoCH-32
Britannium
Bronze

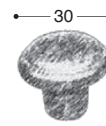

H. tot. = 25
H. min. = 14

PoTR-30
Britannium
Bronze

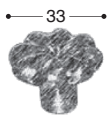

H. tot. = 23
H. min. = 15

PoFI-33
Britannium
Bronze

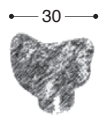

H. tot. = 22
H. min. = 12

PoEd-33
Britannium
Bronze

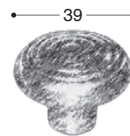

H. tot. = 27
H. min. = 14

PoCH-39
Britannium
Bronze

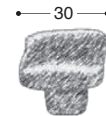

H. tot. = 23
H. min. = 12

PoQ-35
Britannium
Bronze



NB

AZ

VI

WB

AS

AI

OPW

BLK

BRI

RUB

RUW

⇒ pag. 144



Pomolini

Giara Art design

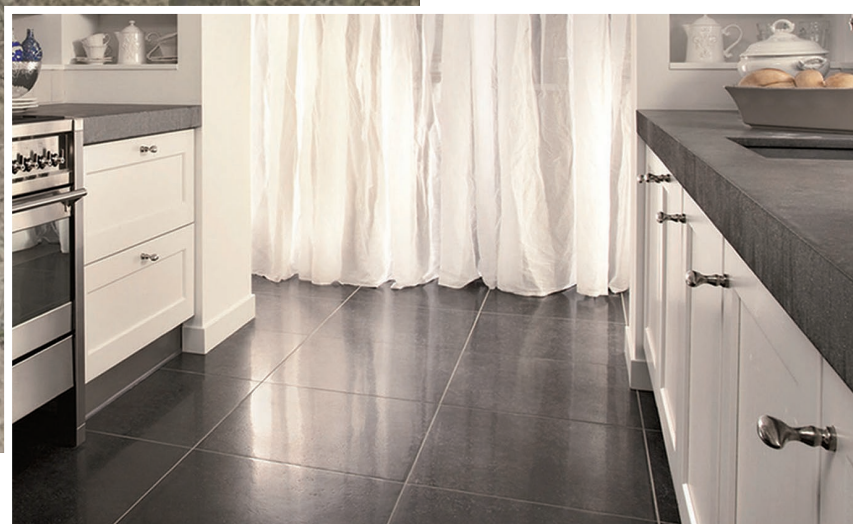

PoIN-35
Britannium
Bronze

H. tot. = 25
H. min. = 16



PoIN-45
Britannium
Bronze

H. tot. = 36
H. min. = 24

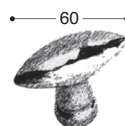

PoIN-60
Britannium
Bronze

H. tot. = 57
H. min. = 37

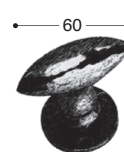

PoIN-60/R3
Britannium
Bronze



PoPLO-45
Britannium

H. tot. = 33
H. min. = 16



PoPLT-35
Britannium

H. tot. = 33
H. min. = 16



PoPLQ-35
Britannium

H. tot. = 33
H. min. = 16



Po9
Britannium
Bronze

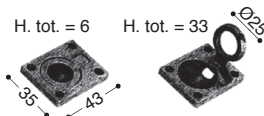

MAR-25
Britannium



NB

AZ

VI

WB

AS

AI

OPW

BLK

BRI

RUB

RUW

⇒ pag. 144



Pomolini

Giara Art design



— 28 —



PoS-28

Britannium
Bronze

H. tot. = 28
H. min. = 12

— 25 —



PoOT-25

Britannium

H. tot. = 26
H. min. = 14

— 20 —



PoTL-20

Britannium

H. tot. = 27
H. min. = 17

— 30 —



PoTL-30

Bronze

H. tot. = 35
H. min. = 20

— 35 —



PoS-35

Britannium
Bronze

H. tot. = 37
H. min. = 17

— 32 —



PoOT-30

Britannium

H. tot. = 35
H. min. = 19

— 30 —



PoTL-30

Britannium

H. tot. = 35
H. min. = 20

— 40 —



PoTL-40

Britannium

H. tot. = 40
H. min. = 25

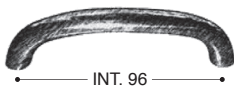

INT. 96

MaL-96

Britannium
Bronze



INT. 128

MaL-128

Britannium
Bronze



NB

AZ

VI

WB

AS

AI

OPW

BLK

BRI

RUB

RUW

⇒ pag. 144

Perla

Giara Art design



45



H. tot. = 33
H. min. = 16

PoPLO-45
Britannium

35



H. tot. = 33
H. min. = 16

PoPLT-35
Britannium

35



H. tot. = 33
H. min. = 16

PoPLQ-35
Britannium



H. tot. = 33

MaCo-66
Britannium



BRI ⇨ pag. 144



Profilo

Giara Art design



Linea essenziale ed elegante caratterizzata da un gradino inciso nel metallo leggermente martellato.

Essential and elegant line characterized by a step engraved in the lightly hammered metal.

Essentielle und elegante Linie, die sich durch eine in leicht gehämmertem Metall eingravierte Stufe auszeichnet.

Ligne essentielle et élégante caractérisée par une marche gravée dans le métal légèrement martelé.

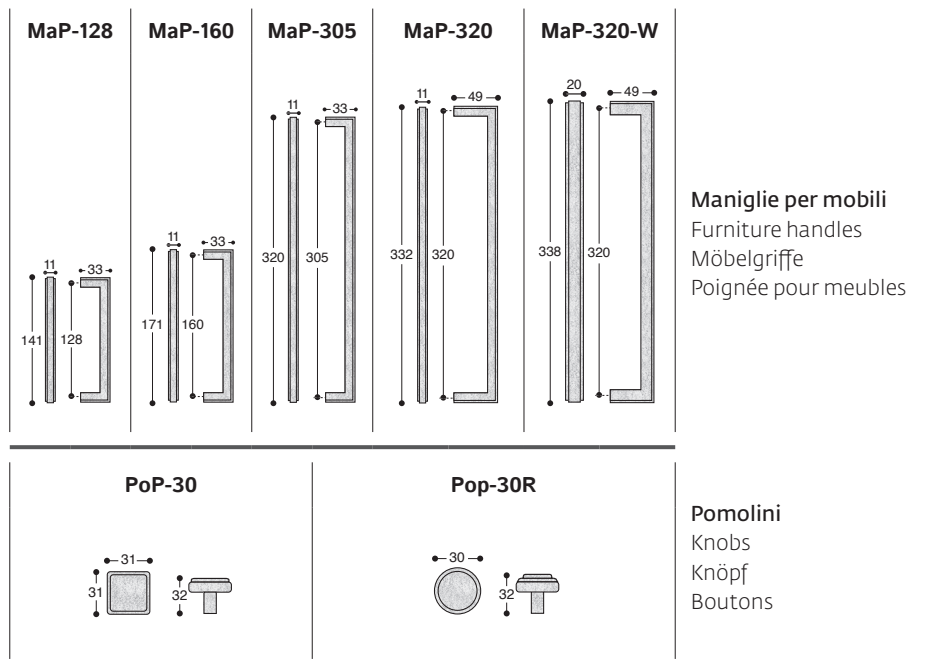

NB AZ VI WB AS AI OPW BLK BRI RUB RUW

⇒ pag. 144



Quadra

Giara Art design

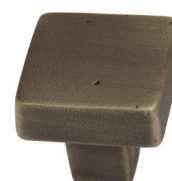
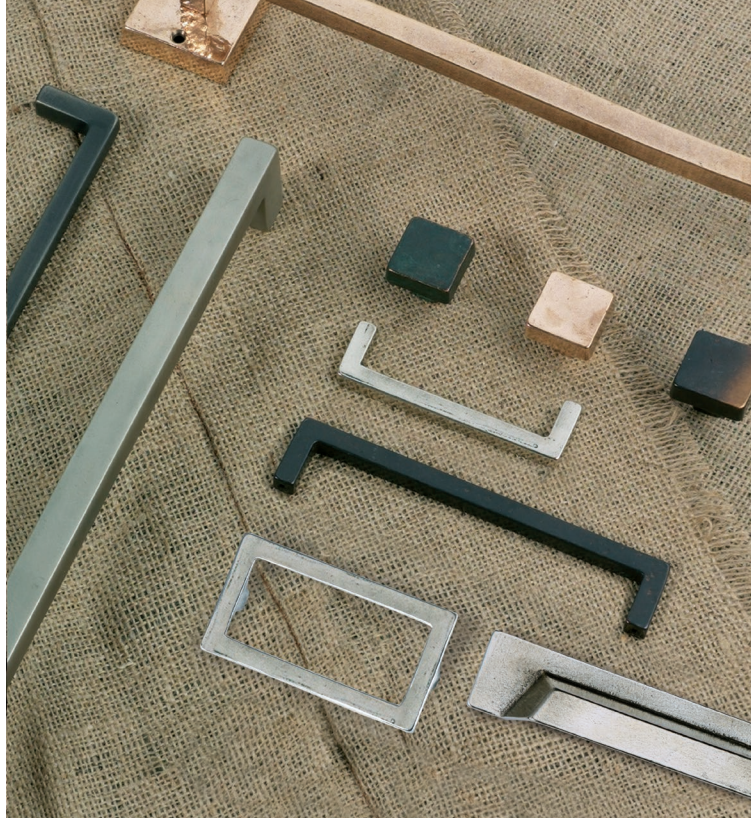

Un grande classico, che si esprime in una collezione completa per l'arredamento e le grandi porte, a proprio agio in ogni contesto.

A great classic, expressed in a complete collection for furniture and large doors, at ease in every context.

Ein großer Klassiker, der in einer kompletten Kollektion für Möbel und große Türen zum Ausdruck kommt und in jede Umgebung passt.

Un grand classique qui s'exprime dans une collection complète pour l'ameublement et les grandes portes, à l'aise partout.



<p>MAQU-96</p>	<p>MAQU-102</p>	<p>MAQU-128</p>	<p>MAQU-152</p>	<p>MAQU-160</p>	<p>MAQU-203</p>	<p>MAQU-254</p>	<p>MAQU-305</p>	<p>MAQU-305W</p>	<p>MAQU-457</p>	<p>MA12-457</p>	<p>Maniglie per mobili Furniture handles Möbelgriffe Poignée pour meubles</p>
<p>RING 1</p>	<p>RING 2</p>	<p>MAFR-102</p>	<p>CQU-150-96</p>	<p>PoQU-33</p>	<p>PoQU-45</p>	<p>Maniglie per mobili Furniture handles Möbelgriffe Poignée pour meubles</p> <p>Pomolini / Knobs Knöpfe / Boutons</p>					

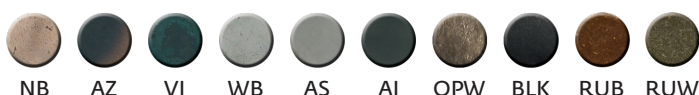

⇒ pag. 144



Torciglia

Giara Art design









Le torsioni evidenziate dalle linee che percorrono le forme fanno di questi accessori un complemento tra i più suggestivi per impatto visivo.

The twists highlighted by the lines that run through the shapes make these accessories one of the most suggestive complements for visual impact.

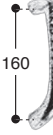
Die Drehungen, die von den Linien, die durch die Formen verlaufen, hervorgehoben werden, verleihen diesem Zubehör eine besondere visuelle Wirkung.

Les torsions accentuées par les lignes qui parcourent les formes font de ces accessoires un complément parmi les plus suggestifs d'un point de vue visuel.



Ma5T-64	Ma5T-96	Ma5T-160	Ma5T-224		
				Maniglie per mobili Furniture handles Möbelgriffe Poignée pour meubles	
64	96	160	224		
Po50-28	Po50-35	Po5T-23	Po5T-33	Po5T-38	
					Pomolini / Knobs Knöpf / Boutons
28	35	23	33	38	
H.tot. = 30 H.min. = 14	H.tot. = 32 H.min. = 15	H.tot. = 26 H.min. = 15	H.tot. = 30 H.min. = 17	H.tot. = 35 H.min. = 20	



NB AZ VI WB AS AI OPW BLK RUB RUW ⇨ pag. 144

Weave

Giara Art design

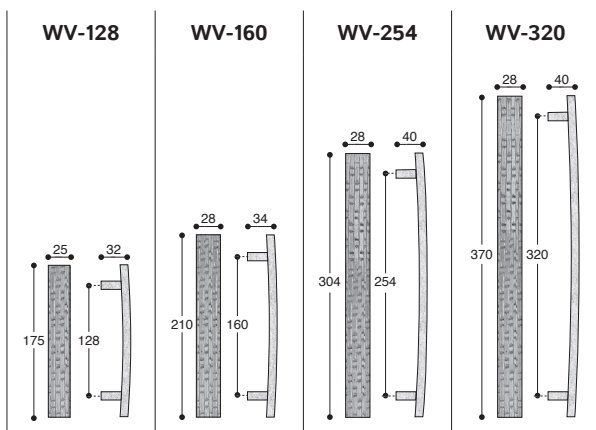

Maniglie per mobili
Furniture handles
Möbelgriffe
Poignée pour meubles

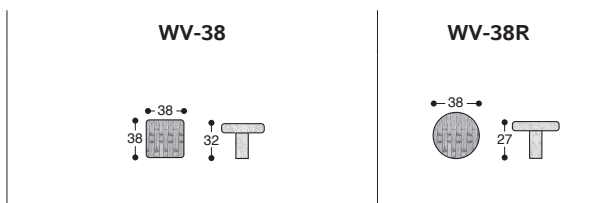

Pomolini
Knobs
Knöpfe
Boutons

Come paglia intrecciata a mano, diventa motivo ornamentale cesellato nel bronzo.

As hand-woven straw, it becomes an ornamental motif chiseled in bronze.

Wie von Hand geflochtenes Stroh wird es zu einem in Bronze gemeißelten Motiv.

Comme de la paille tressée à la main, elle devient un motif ornamental ciselé dans le bronze.



NB AZ VI WB AS AI OPW BLK RUB RUW ⇨ pag. 144



Bocchette Etnici

Giara Art design



33x40



H. tot. = 30
H. min. = 15

PoET4-33
Bronze

47



H. tot. = 26
H. min. = 20

PoET5-47
Bronze

45



H. tot. = 28
H. min. = 20

PoET6-45
Bronze

47



H. tot. = 26
H. min. = 20

PoET8-47
Bronze

40



H. tot. = 4

BHT-40
Britannium
Bronze

70



H. tot. = 4

BHRE
Britannium
Bronze

40



H. tot. = 4

BHQ-40
Britannium
Bronze

33



H. tot. = 4

BHR-70 SFV
Britannium
Bronze

23



H. tot. = 40

BHOV-23
Britannium

26



H. tot. = 42

BHR-26
Britannium

30



H. tot. = 30

BHQ-30
Britannium

33



H. tot. = 4

BHR-70
Britannium
Bronze

23



H. tot. = 40

BKOV-23
Britannium

26



H. tot. = 42

BKR-26
Britannium

30



H. tot. = 30

BKQ-30
Britannium

33



H. tot. = 4

BKR-70
Britannium
Bronze



NB

AZ

VI

WB

AS

AI

OPW

BLK

BRI

RUB

RUW

⇒ pag. 144



Piastrelle

Giara Art design

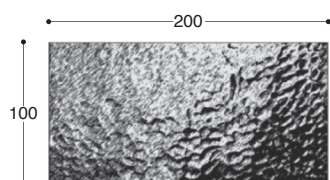
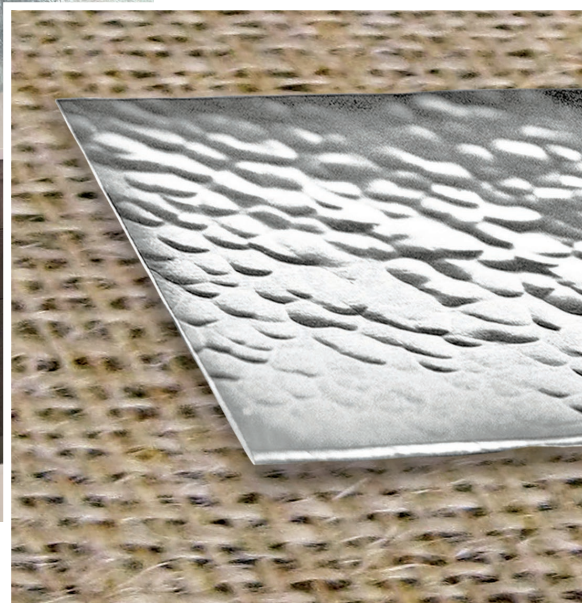

TI-10x20
Britannium

H. tot. = 1,5

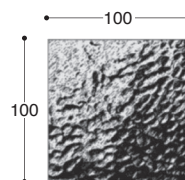

TI-10x10
Britannium

H. tot. = 1,5



BRI ⇨ pag. 144



Leve cerniere

Giara Art design

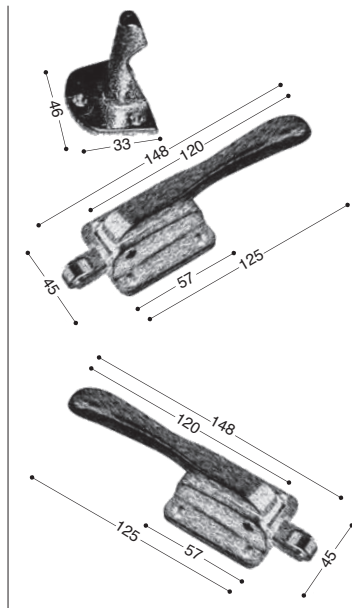
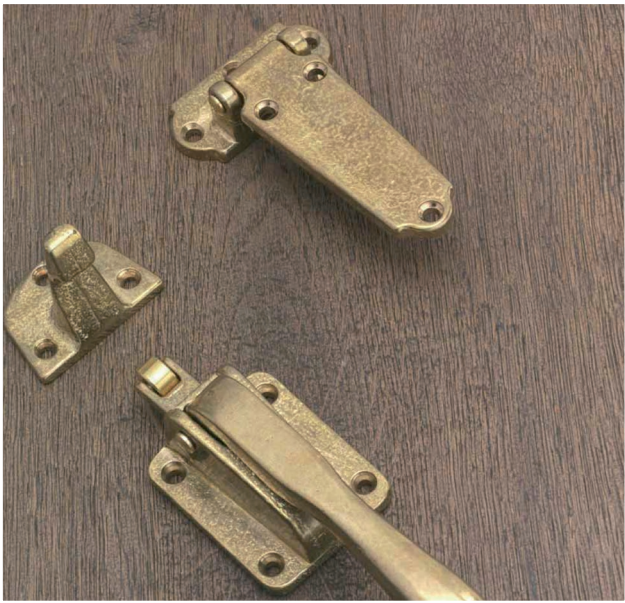

MA-20 dx

MA-20 sx

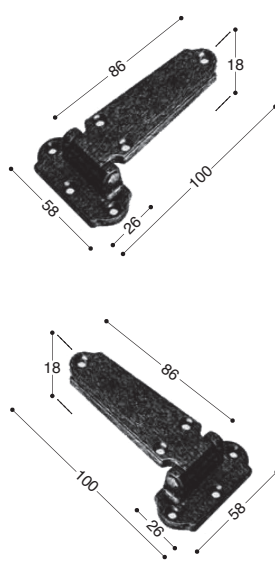

CE-20 dx

CE-20 sx

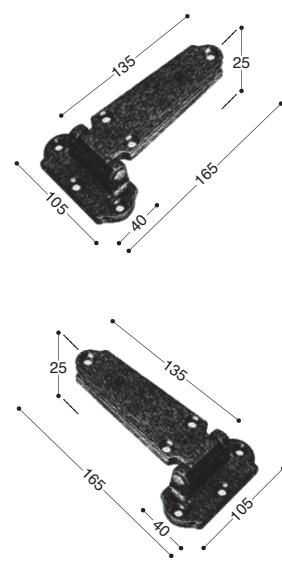

CE-30 dx

CE-30 sx



OA
Ottone antico
Aged brass



OB
Ottone bronzato
Bronze plated



OP
Ottone perlato
Pewter plated

Mano maniglie
Hand of handles / Hand der Griffe / Main poignées

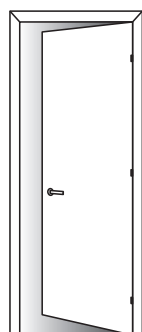

Maniglia DESTRA, cerniere a destra, si impugna con la mano destra per aprire (sia a tirare che a spingere).

RIGHT handle, hinges on the right, you hold with your right hand to open (both pulling and pushing).

RECHTER Griff, Scharnier rechts, wird mit der rechten Hand geöffnet (sowohl ziehen als auch drücken).

Poignée DROITE, charnière à droite, on la saisit de la main droite pour ouvrir (Aussi bien pour tirer que pour pousser).

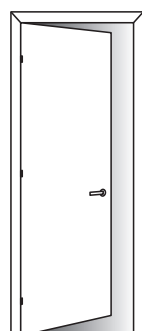

Maniglia SINISTRA, cerniere a sinistra, si impugna con la mano sinistra per aprire (sia a tirare che a spingere).

LEFT handle, hinges on the left, you hold with your left hand to open (both pulling and pushing).

LINKER Griff, Scharnier links, wird mit der linken Hand geöffnet (sowohl ziehen als auch drücken).

Poignée GAUCHE, charnière à gauche, on la saisit de la main gauche pour ouvrir (Aussi bien pour tirer que pour pousser).

Fissaggio maniglioni
Pulls installation / Tuergriffen Befestigung / Montage des tirants

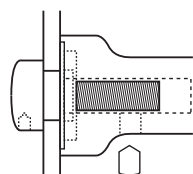

1- Fissaggio con troncone passante
 Fixing with stump through
 Interne Befestigung mit Stab
 Fixation avec partie passante

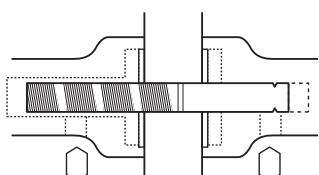

2- Fissaggio UG per paio maniglioni
 UG fixing for two handlebars
 Paarweise Satzbelegung
 Fixation UG pour paires de poignées

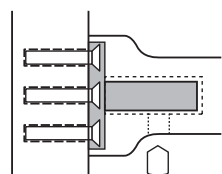

3- Fissaggio frontale con base "dummy"
 Frontal fixation with "dummy" base
 Befestigung vorne mit Basis "dummy"
 Fixation frontale avec base « dummy »



Materiali e finiture / Materials and finishes
Materialien und Finish / Matériaux et finitions

materiale / material / Materialien / matériau

BRITANNIO
BRITANNIUM
BRITANNIUM
BRITANNIUM

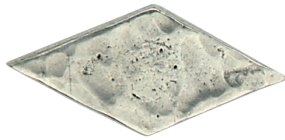

finiture / finishings / Veredelungen / finitions

Britannio
Britannium
Britannium
Britannium

o - BRI

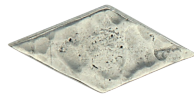

materiale / material / Materialien / matériau

BRONZO ROSSO
RED BRONZE
ROTE BRONZE
BRONZE ROUGE

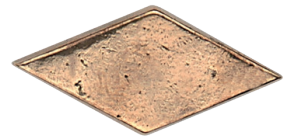

finiture / finishings / Veredelungen / finitions

Bronzo naturale
Natural bronze
Natur Bronze
Bronze naturel

1 - NB

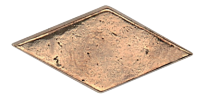

Bronzo antico
Aged bronze
Antik-Bronze
Bronze antique

2 - AZ

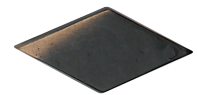

Verde imperiale
Verdegreen
Kupfergrün
Vert impérial

3 - VI

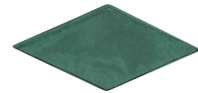

Bronzo grezzo cerato
Rustic waxed bronze
Bronze gewachst
Bronze brut ciré

4 - RUB



GIARA mette a disposizione degli addetti ai lavori il campionario delle finiture, uno strumento prezioso per comprendere appieno le potenzialità del bronzo negli abbinamenti con gli elementi architettonici e di arredamento in studio.

GIARA makes the sample of finishes available to professionals, a precious tool to fully understand the potential of bronze in combinations with architectural and furnishing elements to be used in their offices.

GIARA stellt den Fachleuten das Musterbuch der Oberflächen zur Verfügung. Ein wertvolles Werkzeug, um das Potenzial von Bronze in den Kombinationen mit architektonischen Elementen und Möbeln im Studio besser zu verstehen.

GIARA vous met à disposition des jeux de plaquettes des différentes finitions, un outil précieux pour comprendre pleinement le potentiel du bronze dans les mariages avec les éléments architecturaux et d'ameublement à l'étude.



materiale / material / Materialien / matériau

BRONZO BIANCO
WHITE BRONZE
WEISSBRONZE
BRONZE BLANC



finiture / finishings / Veredelungen / finitions

Bronzo bianco
White bronze
Weiß Bronze
Bronze blanc

5 - WB



Argento antico
Aged silver
Antik-Silber
Argent ancien

6 - AS

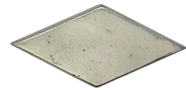

Ferro antico
Aged iron
Veraltetes Eisen
Fer antique

7 - AI

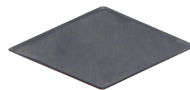

Peltro antico
Aged pewter
Antik-Zinn
Etain antique

Y - OPW



Bronzo nero
Black bronze
Schwarze Bronze
Bronze noir

Z - BLK

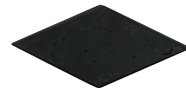

**Bronzo bianco grezzo
cerato**

Rustic waxed white
bronze
Rohe Weissbronze
gewachste
Bronze blanc brut ciré

8 - RUW

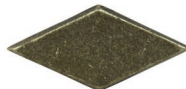

materiale / material / Materialien / matériau

OTTONE
BRASS
MESSING
LAITON

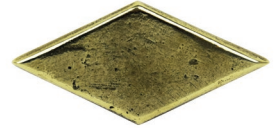

finiture / finishings / Veredelungen / finitions

Ottone naturale
Natural brass
Natur Messing
Laiton naturel

9 - NOT

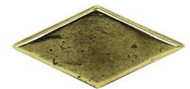

**Ottone naturale
lucidato**
Natural polished brass
Natur Messing poliert
Laiton naturel poli

S - NOL



Ferri / Spindles / Stift / Mécanismes			codice / code Kode / code
	Ferro ad espansione / Screw fastening spindle Spreizstift / Carré avec vis	8 x 65 8 x 45	R1B96500000 R1B9658X045
	Ferro 2 tagli-2 fresate / Spindle 2 cuts-2 milled Stift mit 2 Schnitte-2 Fräsungen / Carré 2 coupes-2 fraiseuses	8 x 85 8 x 95 8 x 100 8 x 110 8 x 120 8 x 130	R1B9628X085 R1B9628X095 R1B9628X100 R1B9628X110 R1B9628X120 R1B9628X130
	Ferro / Spindle / Stift / Carré	8 x 90 8 x 100 8 x 120 8 x 135 8 x 150	R1B9688X090 R1B9688X100 R1B96800000 R1B9688X135 R1B9688X150
	Ferro 2 tagli-2 fresate / Spindle 2 cuts-2 milled Stift mit 2 Schnitte-2 Fräsungen / Carré avec 2 coupes + 2 fraisages	7 x 95 7 x 100	R1B9647X095 R1B9647X100
	Ferro / Spindle / Stift / Carré	7 x 70	R1B96600000
	Ferro con rondella / Spindle with washer Stift mit Unterlegscheibe / Carré avec rondelle	7 x 80	R1B9667X080
	Ferro con 1 fresatura / Spindle with 1 milled Stift mit 1 Schnitte / Carré avec fraiseuse	6 x 32 6 x 35 6 x 80	R1B9616X032 R1B9616X035 R1B9616X080
	Ferro / Spindle / Stift / Carré	6 x 100	R1B96700000
	Ferro con 1 taglio e 1 fresata / Spindle 1 cut 1 milled Stift mit 1 Schnitte-1 Fräsung / Carré 1 coupe-1 fraiseuse	7 x 80	R1B9697X080
	Ferro quadro 8 mm per Wechsel / Entry set 8 mm squared spindle	7 x 90 8 x 100 8 x 120	
	Ferro Dummy / Dummy spindle Dummy Stift / Carré dummy	Q.8	R4T10013
	Dummy filettato M8 / M8 threaded dummy		
	Dummy tondo per fissaggio frontale maniglioni e pomoli Round dummy for pulls and knobs face fixing		
	Troncone filettato e dado per fissaggio passante Passing through bolt and nut Gewindestab und Mutter für interne Befestigung Partie fileté et écrou pour fixation passante	10 x 100	R4F110 + codice finitura dado
	Troncone per fissaggio UG / Back-to-back bolt Stab für paarweise Befestigung / Partie pour fixation UG	10 x 100	R4G03056

Movimenti / Mechanisms / Mechanismus / Mécanismes		codice / code Kode / code	
	Tipo A - DK 7 x 42 - 8 scatti		R1B96000000
	Serratura per DK con chiave / Window DK lock with key DK Fenster mit Schlüssel / Serrure pour DK avec clé		R1972XXX
	Bussolina F1 / Mounting bush Buchse / Douille de serriage	8 x 15 foro 4,5	F1
	Bussolina F2 / Mounting bush Buchse / Douille de serriage	9 x 27 foro 5	F2
	Bussolina F3 / Mounting bush Buchse / Douille de serriage	12 x 27 foro 5	F3



CONFEZIONE - I prodotti delle collezioni Bronze e Giara, dopo un attento controllo manuale, vengono confezionati singolarmente in sacchetti di juta.

PULIZIA - Per la pulizia dei nostri prodotti si raccomanda di usare un panno soffice eventualmente inumidito. Per i prodotti in Britannio è possibile utilizzare prodotti per l'argenteria.

PACKAGING - Bronze and Giara products, after a deep inspection, are packed individually into jute bags.

CLEANING - For the cleaning of our products we recommend to use a soft cloth. For the Britannium products it's possible to use a silver polishing compound.

VERPACKUNG: Die Produkte der Bronze und Giara Kollektionen werden nach Sörfältigem Handkontrolle einzeln in Jute-Beutel verpackt.

REINIGUNG: Verwenden Sie ein weiches Tuch. Für Britannio verwenden Sie Produkte für Silberwaren.

EMBALLAGE - Les produits des collections Bronze et Giara, après un contrôle manuel attentif, sont emballés individuellement dans des sacs de jute.

NETTOYAGE - Pur le nettoyage de nos produits, il est recommandé d'utiliser un chiffon doux éventuellement humidifié. Pour le produits en Britannium, vous pouvez utiliser des produits pour l'argenterie.

project by
BCF design

photos by
Vittoria Pasini
Eros Mauroner

*Si ringrazia la rivista Casantica per la gentile
concessione delle immagini del suo archivio.*

Giara
Art design

la nostra terra... le nostre tradizioni... il nostro lavoro

Renaissance
CUSTOM HARDWARE

A valued brand of

FR International

FR International, LLC

1011 3rd Avenue S.W.

Carmel, Indiana USA 46032

1-800-238-9711

www.FRInternational.com